

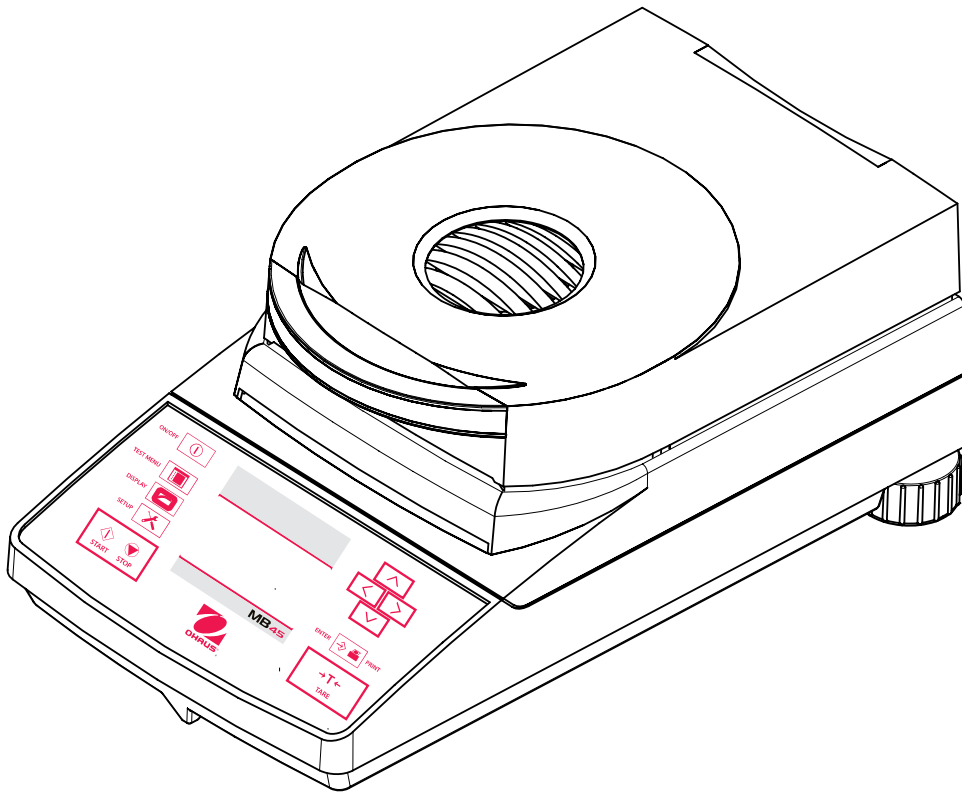

Instruction Manual

MB45 Moisture Analyzer



Contents

OVERVIEW OF CONTROLS	4
1. GETTING TO KNOW YOUR MOISTURE ANALYZER	5
1.1 Introduction	5
1.2 Overview of the Moisture Analyzer	5
1.3 What is a Moisture Analyzer ?	5
1.4 Safety is first	7
1.5 What you should know about these instructions	9
2. INSTALLATION	10
2.1 Unpacking and checking the standard equipment	10
2.2 Selecting the location	11
2.3 Installing the heat shield, draft shield and pan support	11
2.4 Leveling the Moisture Analyzer	12
2.5 Connecting to a power supply	12
2.6 Switching the Moisture Analyzer on or off	13
3. MAKING A SIMPLE MEASUREMENT	14
4. THE MENUS	17
4.1 What are the menus?	17
4.2 Menu operation	18
5. ANALYZER SETUP	20
5.1 Lockout	20
5.2 Weight calibration	21
5.3 Temperature calibration	22
5.4 Language setting	23
5.5 Audible signal level	23
5.6 Time and date setting	24
5.7 RS232 settings	25
5.8 Setting print and GLP printing on or off	27
5.9 Adjusting display contrast and brightness	28
5.10 Factory reset	29

Contents (continued)

6.	OPERATING YOUR MOISTURE ANALYZER	30
6.1	The operating concept	30
6.2	Entering test ID	30
6.3	Setting the drying profile	31
6.4	Setting the drying temperature	33
6.5	Selecting the switch-off criterion	34
6.6	Result	36
6.7	Custom units	37
6.8	Target weight	39
6.9	Print interval	39
6.10	Saving test setup	40
6.11	Exiting test setup and not saving changes	40
6.12	Running the test setup	41
6.13	Displaying data during run mode	43
6.14	Statistical data	43
7.	USING THE LIBRARY	44
8.	HOW TO OBTAIN THE BEST RESULTS	45
8.1	Measurement principle of the Halogen Moisture Analyzer	45
8.2	Sampling and sample preparation	46
8.3	Selection of the drying temperature	49
8.4	Selection of the drying program	50
8.5	Selection of the drying time	52
8.6	Analysis of the drying profile	53
9.	PRINTING TEST DATA	54
9.1	RS232 command table	56
9.2	RS232 Pin out	56

Contents (continued)

10. CARE AND MAINTENANCE	53
10.1 Cleaning interior/exterior components.....	57
10.2 Replacing power line fuse.....	59
10.3 Resetting the dryer thermal overload device.....	59
10.4 Troubleshooting.....	60
10.5 Error detection	61
10.6 Service information	61
10.7 Accesories	61
11 TECHNICAL DATA	62
11.1 Specifications	62
11.2 Compliance	63
A1 APPENDIX - APPLICATION EXAMPLES	64

Overview of Controls

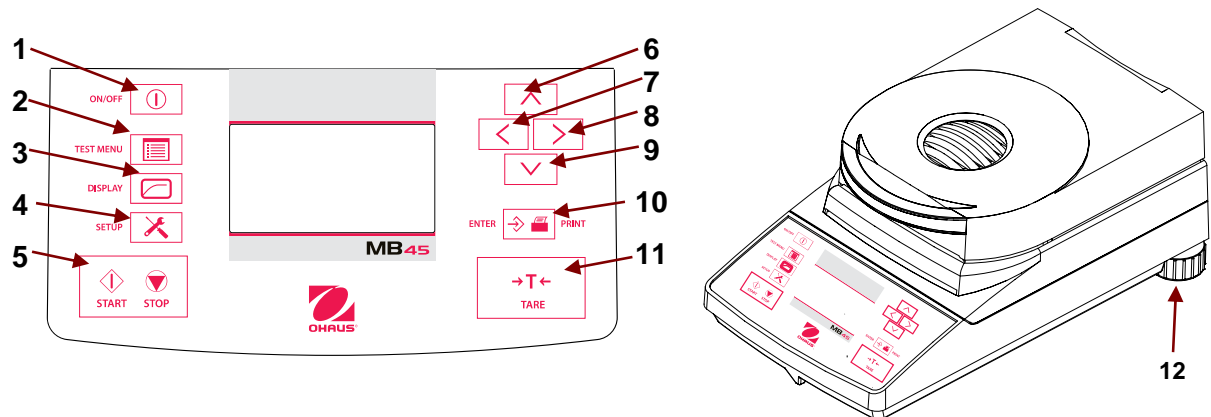

1		Turns On or Off display and fan. On returns with last screen. (All modes)
2		When pressed, selects Test Library screen.
3		When pressed, returns to current test, or cycles through several display screens.
4		When pressed, brings up analyzer Setup menu.
5		When pressed, either starts or stops the drying process.
6		When pressed, travels up through menu options, selects alphanumeric characters.
7		When pressed, travels to the left through displays.
8		When pressed, travels to the right through displays.
9		When pressed, travels down through menu options, selects alphanumeric characters.
10		When pressed, accepts selection/input (Select mode) or sends Print command (Run mode).
11		When pressed, performs Tare function. (Pressing during a test has no effect.)
12	Leveling feet	Used to level the Moisture Analyzer.

1. Getting to know your Moisture Analyzer

This section provides you with essential information on your MB45 Moisture Analyzer. Please read through the section carefully even if you have previous experience with OHAUS Moisture Analyzers and be sure to familiarize yourself with the safety notes.

1.1 Introduction

Thank you for deciding to purchase a MB45 Halogen Moisture Analyzer from Ohaus. Behind your instrument stands OHAUS, a leading manufacturer of precision Moisture Analyzers, Balances, Scales and Indicators. An Aftermarket Department with trained instrument technicians is dedicated to provide you with the fastest service possible in the event your instrument requires servicing. OHAUS also has a Customer Service Department to answer any inquiries regarding applications and accessories.

To ensure you make full use of the possibilities offered by your Moisture Analyzer, please read the manual completely before installation and operation.

1.2 Overview of the Moisture Analyzer

The Moisture Analyzer offers a high level of operating convenience and useful functions to make accurate measurements.

The Moisture Analyzer has the following features:

- Up to twice as fast as IR Moisture Analyzers.
- Fully programmable with front panel controls.
- Extremely rugged and chemically resistant construction.
- Ergonomic operating controls and a large, easily readable display.
- Easy to follow menus for simplified operation.
- Built-in functions for manual, automatic timing, printing intervals, and custom units.
- Built-in selectable drying profiles.
- Able to set step heating levels to accommodate a variety of sample types.
- Built-in library stores up to 50 samples complete with setup parameters and statistics.
- Built-in RS232 communication interface.
- Any of five languages (English, Spanish, French, German, Italian) are selectable on the display.
- Display contains all test data during drying process.
- A variety of accessories includes disposable pan liners, calibration mass, temperature calibration kit, interface communication cables, printer, and a security device.

1.3 What is a Moisture Analyzer?

The Ohaus Halogen Moisture Analyzer can be used to determine the moisture content of practically any substance. The instrument operates on the thermogravimetric principle: At the start of the measurement, the Moisture Analyzer determines the weight of the sample; the sample is then quickly heated by the integral halogen dryer unit and moisture vaporizes. During the drying operation, the instrument continuously determines the weight of the sample and displays the result. On completion of drying, result is displayed as % moisture content, % solids, weight or % regain.

1.3 What is a Moisture Analyzer? (cont.)

Of particular importance in practice is the rate of heating. In comparison with conventional infrared heating or the drying oven method, for example, the halogen dryer of your instrument needs a shorter time to reach its maximum heating power. It also allows the use of high temperatures; an additional factor in shortening the drying time. Response times for the control of production are shorter resulting in increased productivity.

All parameters of a measurement (drying temperature, drying time, etc.) can be pre-selected. The Moisture Analyzer offers many other possibilities. A few of these are listed here:

- The integrated database for drying procedures stores the settings for your samples.
- The drying characteristics can be matched to the type of sample.
- You can choose between various types of result displays at any time.
- Your settings and measurement results can be recorded and stored.
- Built-in battery backup stores valuable data during a power failure.

Even though the Moisture Analyzer contains many functions, operation remains simple. The three button controls on the front panel: Test Menu, Display and Setup allows entry into a variety of displays which includes a test library where previous samples are recorded along with the test parameters so that a similar sample can be run without the need to enter all new data. There are additional displays which indicate the test ID number, selected temperature, actual temperature, time, initial weight and moisture content in percent, solids in percent, grams or custom unit, % regain and a graphical display which illustrates the time and percentage.

Your Moisture Analyzer conforms with all common standards and directives. It supports standard procedures, work techniques and records as required by **GLP (Good Laboratory Practices)** and **SOP (Standard Operating Procedure)**. We recommend the use of the OHAUS AS-142 Printer. Your Moisture Analyzer has a CE declaration of conformity and OHAUS is registered to ISO 9001 - Quality Management System.

1.4 Safety is first



Your Moisture Analyzer employs state of the art technology and meets the latest demands regarding instrument safety. Improper operation can endanger personnel and can cause property damage. For safe and dependable operation, please comply with the following instructions:

- The Moisture Analyzer is used for determination of the moisture in samples. Please use the instrument exclusively for this purpose. Any other type of use can endanger personnel and damage the instrument or other property.
- The Moisture Analyzer must not be operated in a hazardous environment and only under ambient conditions specified in these instructions.
- The Moisture Analyzer may be operated only by trained personnel who are familiar with the properties of the samples used and with the handling of the instrument.
- Your Moisture Analyzer is supplied with a 3-pin power cable with an equipment grounding conductor. Only extension cables which meet the relevant standards and also have an equipment grounding conductor may be used. Intentional disconnection of the equipment grounding conductor is prohibited.



The Halogen Moisture Analyzer works with heat!

- Ensure sufficient free space around the instrument to avoid heat accumulation and overheating (approximately 1 m free space above the instrument).
- Never place flammable materials on, below or next to the instrument as the area around the dryer unit warms up.
- Exercise caution when removing the sample. The sample itself, the sample chamber and any sample containers may still be very hot.
- During operation, you should never open the dryer unit as the ring-shaped heating element or its protective glass can reach 400°C! If you have to open the dryer unit on occasion, disconnect the instrument from the power supply and wait until the dryer unit has cooled down completely.

1.4 Safety is first (Cont.)

Certain samples require special care!

With certain types of samples, there is a possibility of danger to personnel or damage to property through:



Fire or explosion:

- Flammable or explosive substances;
- Substances containing solvents;
- Substances which release flammable or explosive vapors when heated. With such samples, work at a drying temperature that is low enough to prevent the formation of flames or an explosion and wear protective goggles. Should there be any uncertainty regarding the flammability of a sample, always work with a small sample (maximum. 1 gram). In such cases, **never leave the instrument unattended!** In cases of doubt, perform a careful risk analysis.

Poisoning, burning:

- Substances which contain toxic or caustic components. Such substances may be dried only in a fume hood.

Corrosion:

- Substances which release corrosive vapors when heated (e.g. acids). In the case of such substances, we advise you to work with small amounts of samples as the vapor can condense on cooler housing parts and cause corrosion. Please note that the user always takes responsibility and assumes liability for damage caused by use of the types of samples mentioned above!
- Never make any modifications or constructional alterations to the instrument and use only original spare parts and optional equipment from Ohaus Corporation.
- Your Moisture Analyzer is a rugged, precision instrument – but you should still treat it carefully; it will then provide you with many years of trouble-free operation.
- Please comply with all notes and instructions in these operating instructions. Keep the instructions in a safe place where they are immediately at hand if any points are unclear.



APPLICATION DISCLAIMER:

- Moisture determination applications must be optimized and validated by the user according to local regulations. Application specific data provided by Ohaus is provided for reference purposes only. Ohaus waives all liability for applications based on this data.

1.5 What you should know about these instructions

These instructions guide you step by step through the operation of your Moisture Analyzer. Section 2 provides detailed installation instructions. Section 3 allows you to perform a simple measurement. Section 4 explains the menu operation. Section 5 explains how to set the analyzer up. Section 6 covers the configuring and operation of the analyzer. Section 7 explains the use of the built-in library. Section 8 explains how to obtain the best results. Section 9 details printing operations. Section 10 covers maintenance. A1 is an appendix with application samples.

The following graphic orientation aids represent certain functions, notices and controls. These graphic aids are not meant to be step by step operational procedures but simply a guide.



This hand symbol indicates pressing a button.



This representation symbolizes the current display of your Moisture Analyzer.

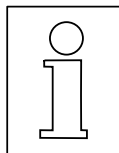

This symbol indicates additional information and instructions which facilitate your handling of the Moisture Analyzer and contribute to proper and economical use.



This symbol indicates safety and hazard instructions which must be complied with. Nonconformance with such instructions can lead to personal injuries to the user, damage to the Moisture Analyzer or other tangible assets or to malfunctions.

2. Installation

In this section, you will learn how you unpack and install your new Moisture Analyzer and prepare it for operation. On completion of the steps described in this section, your Moisture Analyzer is ready for operation.

2.1 Unpacking and checking the standard equipment

Open the package and remove the instrument and the accessories. Check the completeness of the delivery.

The following accessories are part of the standard equipment of your new Moisture Analyzer.

- 1 Box, Aluminum sample pans
- 1 Pan support
- 1 Specimen sample (circular, absorbent cellulose disk)
- 1 Draft shield element
- 1 Heat shield
- 1 Power cable
- 1 Set of operating instructions
- 1 Warranty card

Remove packing material from the instrument.

Check the instrument for transport damage. Immediately inform your Ohaus dealer if you have complaints or parts are missing.

Store all parts of the packaging. This packaging guarantees the best possible protection for the transport of your instrument.

2.2 Selecting the Location

The Moisture Analyzer should always be used in an environment which is free from excessive air currents, corrosives, vibration, and temperature or humidity extremes. These factors will affect displayed weight readings.

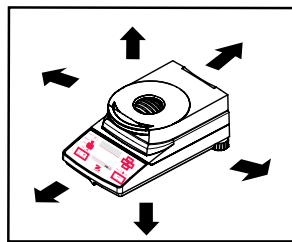
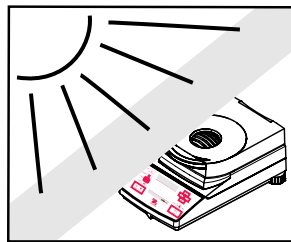
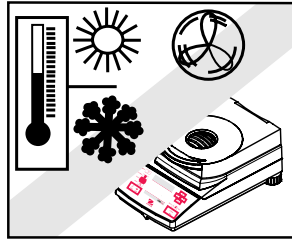
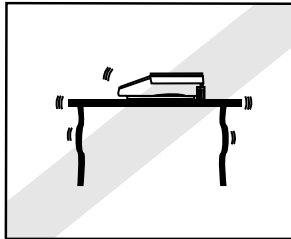

DO NOT install the Moisture Analyzer:

- Next to open windows or doors causing drafts or rapid temperature changes.
- Near air conditioning or heat vents.
- Near vibrating, rotating or reciprocating equipment.
- Near magnetic fields or equipment that generate magnetic fields.
- On an unlevel work surface.
- In confined areas, allow sufficient space around the instrument for ease of operation and keep away from radiating heat sources.

2.3 Installing the Heat Shield, Draft Shield and Pan Support

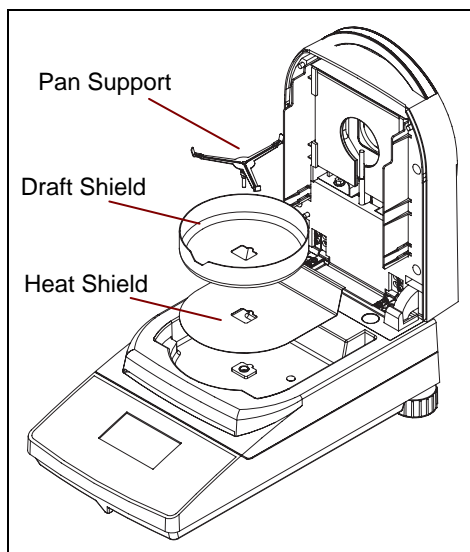

Lift the cover straight up and install the heat shield in the base of the heating chamber.

Install the draft shield element (only one position possible) on top of the heat shield.

Install the pan support into position. Turn the pan support until it engages. In the locked position, the rear arm of the pan support points directly towards the rear of the analyzer.

2.4 Leveling the Moisture Analyzer

Exact horizontal positioning and stable installation are prerequisites for repeatable results. To compensate for small irregularities or inclinations at the location, the instrument can be leveled.

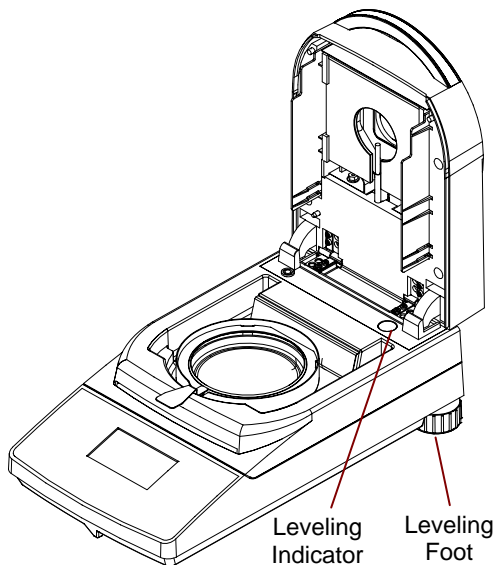

Adjust the leveling feet at the rear of the Moisture Analyzer until the air bubble in the indicator is centered. The level indicator is located under the cover towards the rear of the Moisture Analyzer.

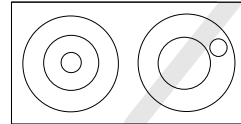

NOTE: The instrument should be leveled each time its location is changed.

2.5 Connecting to a Power Supply



Check to ensure the voltage identification label on the Moisture Analyzer matches your local line voltage. If this is not the case, do not connect the Moisture Analyzer to the power supply, contact your responsible OHAUS dealer.

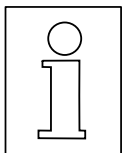

The halogen dryer unit is designed to operate at a specific line voltage (120 V ac or 240 V ac). The dryer unit is installed at the factory and is matched to the particular line voltage of the country of destination.



Connection to a line voltage that is too high can lead to burning out the halogen heater, whereas, a supply voltage that is too low will prolong the drying process and the instrument may not operate properly.

2.5 Connecting to a Power Supply (cont)

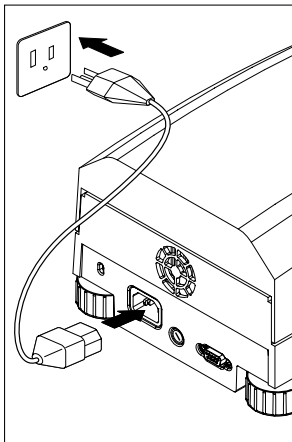

Connect the power cord supplied to the three pin connector located at the rear of the Moisture Analyzer and to a power source. The Moisture Analyzer becomes operational as soon as power is applied. The display will remain off until the **On/Off** button is pressed.

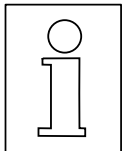

Allow the Moisture Analyzer to warm up for at least 30 minutes to enable it to adapt itself to the ambient conditions. If the Moisture Analyzer has been stored in a very cold environment before installation, it may require several hours for it to stabilize.



WARNING:

If the power cable supplied is not long enough, use only a **proper 3-pin extension cable with an equipment grounding connector**.

2.6 Switching the Moisture Analyzer on and off

Your Moisture Analyzer is on at all times when connected to a power source. The display can be turned on or off.



To **switch the Moisture Analyzer on**, press the **On/Off** button. An internal diagnostic test is performed; the display lights and the logo and product name appears followed by the initial display.

TEST ID:	-DEFAULT-
TEMP/TIME:	100°C / 10:00
TARG. WGT:	1.000 G
CLOSE COVER	0.000
	* GRAMS

To **switch the Moisture Analyzer off**, press the **On/Off** button. After the analyzer has been switched off, it is in the standby mode. If you wish to perform a test, press the **On/Off** button again.

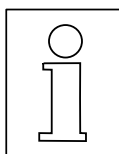

As your Moisture Analyzer needs no warm-up time when in the standby mode and is immediately ready for testing samples, we advise you to switch the display off by use of the On/Off button and not to disconnect it from the power supply. This also ensures that the Moisture Analyzer is always in thermal equilibrium.

3. Making a simple measurement

With your Moisture Analyzer powered on, you are ready to operate for the first time and perform a simple measurement. For this simple test, you will enter the Test Menu and enable the test. By doing this test, you will become familiar with the instrument and the various displays.

Included with your Moisture Analyzer is a specimen sample for your first measurement. This sample is an absorbent glass fiber pad. During your first measurement, the instrument operates with the factory settings.



If the display is not visible and the unit is plugged into a power source, press the On/Off button.

TEST ID:	-DEFAULT-
TEMP/TIME:	100°C / 10:00
TARG. WGT:	1.000 G
CLEAR PAN PRESS TARE	0.000 * GRAMS

The display indicates the parameters for DEFAULT settings. Follow the instructions on the lower left side of the display.

NOTE: If the unit has been operated, the default test settings may have changed. If required, see Section 6 to reset the test parameters.

For this simple test, the default settings are:

Drying temperature is set to:	100°C
Profile is set to:	standard
Switch Off is set to:	timed 10:00 minutes
Display is set to:	% moist
Print interval is set to:	OFF
Target weight is set to:	1 grams
Save is set to:	NO

Open the cover on the Moisture Analyzer.

Clear the pan.

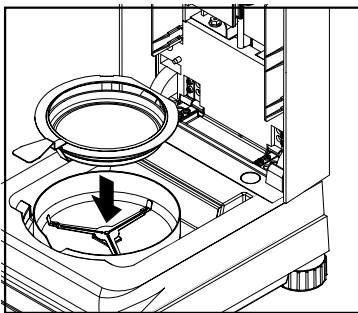

Place the empty sample pan in the pan handler (this is possible without tilting the sample pan if you insert this in the pan handler from the side directly below the round flange). Place the pan handler in the sample chamber. Ensure that the tongue of the pan handler fits exactly in the slot of the draft shield element. The sample pan must lie flat in the pan handler.

Note: It is advisable for you to work with the pan handler at all times. The pan handler is ergonomic, safe and provides protection against possible burns due to a hot sample pan.

Place the specimen sample in the sample pan (glass fiber pad).

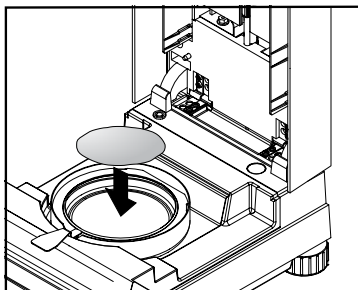

Press the Tare button.



This sets the Moisture Analyzer to zero. A new display now appears with instructions.

3. Making a simple measurement (cont)

TEST ID:	-DEFAULT-
TEMP/TIME:	100°C / 10:00
TARG. WGT:	1.000 G
SAMPLE <.500G	0.000 * GRAMS

Wet the specimen sample with a 0.5 to 1 gram of water.
NOTE: Minimum sample size must be greater than 0.5 gram.

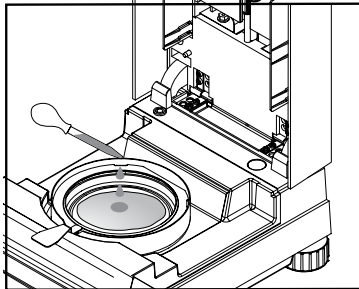

TEST ID:	-DEFAULT-
TEMP/TIME:	100°C / 10:00
TARG. WGT:	1.000 G
CLOSE COVER	0.930 * GRAMS

Close the cover.



Starting the test

Press the **Start/Stop** button. The Moisture Analyzer starts the drying and measurement process.

TEST ID:	-DEFAULT-
TEMP/TIME:	100°C / 10:00
INITIAL WT:	0.930 GRAMS
70°C	4.04
08:11	* %MOISTURE

Drying and measurement

You are now able to follow the progress of the drying cycle on the display. This first display comes up automatically when the test was started.

Observing the test progress

There are six displays available when the Moisture Analyzer is running a test. The **Display** button on the front panel when pressed repeatedly accesses each of the six displays during the run mode of the Analyzer and cycles through each display in the order shown below.

The displays indicate the Test ID, Temperature/Time, Initial Weight, actual temperature, elapsed time duration of the test, either moisture, solids, grams, percent regain, a graph representing the actual test progress and statistics at the end of the test.

Observing the test progress (cont)

Press the **Display** button repeatedly to view the progress of the sample test with different displays.

The test automatically stops at the end of 10:00 minutes. If you want to end the test sooner, press the **START/STOP** button.

TEST ID: -DEFAULT-	
TEMP/TIME: 100°C / 10:00	
INITIAL WT: 0.930 GRAMS	
100°C	100.00
08:11	* %MOISTURE

Press
Display



TEST ID: -DEFAULT-	
TEMP/TIME: 100°C / 10:00	
INITIAL WT: 0.930 GRAMS	
100°C	0.00
08:11	* %SOLIDS

Press
Display



TEST ID: -DEFAULT-	
TEMP/TIME: 100°C / 10:00	
INITIAL WT: 0.930 GRAMS	
100°C	1000.00
08:11	* %REGAIN

Press  Display

STATISTICS	
SAMPLE N:	0
LAST DATA:	0.00
MEAN X:	0.00
STD. DEV S:	N<5
MIN X:	0.00
MAX X:	0.00

Press
Display

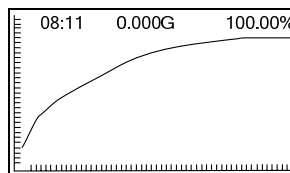

Press
Display



TEST ID: -DEFAULT-	
TEMP/TIME: 100°C / 10:00	
INITIAL WT: 0.930 GRAMS	
100°C	0.000
08:11	* GRAMS

Press  Display

TEST ID: -DEFAULT-	
TEMP/TIME: 100°C / 10:00	
INITIAL WT: 1.000 G	
TEST OVER...	100.00
10:00	* %MOISTURE

Congratulations! You have just performed your first measurement with your moisture analyzer.

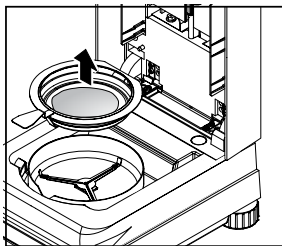

Carefully remove the sample pan handler from the drying area.

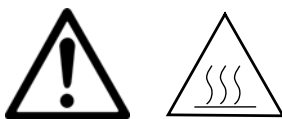

Warning: As the pan and sample may still be hot, you should let these cool down before removing the pan from the pan handler!

To remove the sample pan from the pan handler, lift the pan slightly from below and pull it sideways out of the pan handler (if you no longer need the sample and pan, you can simply tilt the pan handler until the pan slides out).



The last display from the test remains on the screen until you press the **Tare** button. Press the **Tare** button. This sets the Moisture Analyzer to zero. The display returns to the first test display, ready to repeat the test.

If you want to get out of the test mode, simply press any other button on the unit. Continue to review the rest of this manual and become familiar with the menus.

4. The menus

4.1 What are the menus?

There are two sets of menus used in the Moisture Analyzer. One is the Setup menu which is activated by the **Setup** button. This menu permits calibration, adding custom units, language selection, beeper volume settings, time and date format, communication settings and print criteria. The Test menu is activated by the **Test Menu** button. This menu permits setting up new test parameters which includes test temperatures, ID, profiling, timed information, type of display, print intervals, editing and running the test. A test library is also included which holds data for up to 50 tests which can be recalled and run at any time. The contents of each menu are shown below.

SETUP	TEST MENU
<ul style="list-style-type: none"> — Lockout — Weight Calibration — Temperature Calibration — Language <ul style="list-style-type: none"> English, Deutsch, Español, Français, Italiano — Beeper <ul style="list-style-type: none"> — Low, High, Off — Time-Date <ul style="list-style-type: none"> — Date Format, Set Date — Time Format, Set Time — RS232 <ul style="list-style-type: none"> — Baud Rate <ul style="list-style-type: none"> 1200, 2400, 4800, 9600, 19,200 — Parity <ul style="list-style-type: none"> Odd, Even, None — Data Bits <ul style="list-style-type: none"> 7, 8 — Stop Bits <ul style="list-style-type: none"> 1, 2 — Handshake <ul style="list-style-type: none"> None, XON-XOFF, RTS-CTS — Print <ul style="list-style-type: none"> — Print On/Off — GLP On/Off — Display <ul style="list-style-type: none"> — Contrast — Brightness — Factory Reset 	<ul style="list-style-type: none"> Test Library <ul style="list-style-type: none"> — Edit Test <ul style="list-style-type: none"> — Test Parameters <ul style="list-style-type: none"> — Test ID: — Profile: <ul style="list-style-type: none"> Standard Fast Ramp Step — Dry Temp: — Switch Off: <ul style="list-style-type: none"> Timed-Switch Off Man.-Use Start/Stop AFREE - Wt loss/time <ul style="list-style-type: none"> A90 - <1MG in 90 sec. A60 - <1MG in 60 sec. A30 - <1MG in 30 sec. — Result: <ul style="list-style-type: none"> % Moisture Custom Units Grams % Regain % Solids — Custom <ul style="list-style-type: none"> — Factor, Exponent, LSD — Target Wt: — Print Int: <ul style="list-style-type: none"> — Off, 1, 3, 5, 10, 30 Sec — 1, 2, 5 Min. — Save Test: — 01 <ul style="list-style-type: none"> — Load Test — Edit Test — Delete Test — 02 <ul style="list-style-type: none"> — Load Test — Edit Test — Delete Test — 03 <ul style="list-style-type: none"> — Load Test — Edit Test — Delete Test • • • — 50 <ul style="list-style-type: none"> — Load Test — Edit Test — Delete Test

4.2 Menu operation

In this section you will learn how to work with the menus. Information regarding the individual menu options and available settings can be found in the following sections.

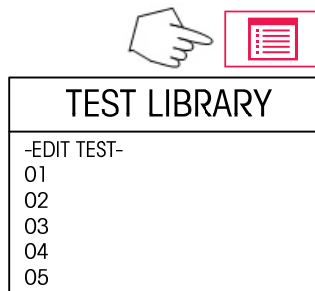

How to select the test menu

Pressing the **Test Menu** button accesses the Test Library menu. The Test Library contains up to 50 tests. All tests which were previously entered can be recalled and the parameters for the recalled test when selected will be repeated.

How to exit the test menu without making changes

Press the **Display** button.

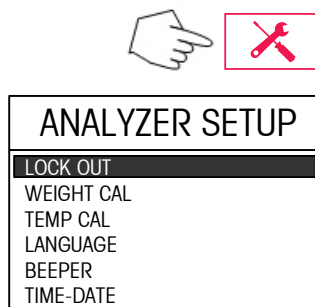

How to select the setup menu

Pressing the **Setup** button will give you access to the Analyzer Setup menu.

How to exit the setup menu without making changes

Press the **Display** button.

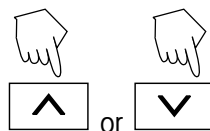

How to select the menu options

Press either the up or down arrow buttons and scroll to the desired option. Each time the arrow \wedge button is pressed, the menu advances to the next option. Each time the \vee arrow button is pressed, the menu returns to the previous menu option. When scrolling past the last item, the screen displays the next item.

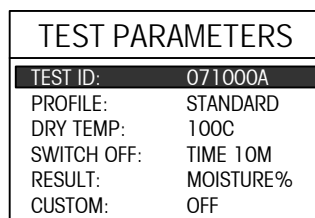

How to enter the menu option

Press the **Enter** button when the desired menu option is highlighted.

4.2 Menu operation (cont)

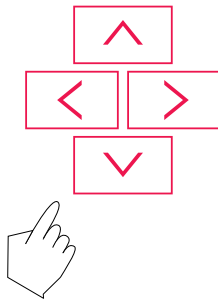

How to enter alpha numeric data and make selections

Certain menu options can have names or numerical entries made. When prompted to enter information, use the arrow buttons as follows:

Press the \wedge and \vee arrow buttons to scroll through numbers or alphabet and to highlight an item in a menu.

Press the $\>$ arrow button to advance to the next character in the display or it can be used to highlight an item in a menu.

Press the \lt arrow button to go back to the previous character in the display or it can be used to highlight an item in a menu.

Press the **Enter** button to accept entry.

How to access various displays

There are six displays available when the Moisture Analyzer is running a test and at the end of the test. The **Display** button on the front panel when pressed repeatedly accesses each of the six displays during the run mode of the analyzer and cycles through each display in the order shown below. The displays indicate the Test ID, Temperature/Time, Initial Weight, actual temperature, elapsed time duration of the test, either moisture, solids, percent regain, grams, a graph representing the actual test progress and statistics.

TEST ID:	-DEFAULT-
TEMP/TIME:	100°C / 10:00
INITIAL WT:	0.930 GRAMS
100°C	100.00
08:11	* %MOISTURE

Press
Display

TEST ID:	-DEFAULT-
TEMP/TIME:	100°C / 10:00
INITIAL WT:	0.930 GRAMS
100°C	0.00
08:11	* %SOLIDS

Press
Display

TEST ID:	-DEFAULT-
TEMP/TIME:	100°C / 10:00
INITIAL WT:	0.930 GRAMS
100°C	1000.00
08:11	* %REGAIN

Press Display

STATISTICS	
SAMPLE N:	0
LAST DATA:	0.00
MEAN X:	0.00
STD. DEV S:	N<5
MIN X:	0.00
MAX X:	0.00

Press
Display

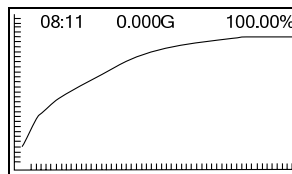

Press
Display

TEST ID:	-DEFAULT-
TEMP/TIME:	100°C / 10:00
INITIAL WT:	0.930 GRAMS
100°C	0.000
08:11	* GRAMS

Press Display

5. Analyzer Setup

The Analyzer Setup menu is activated by pressing the **Setup** button. The menu contains: lockout, weight and temperature calibration, language selection, beeper volume settings, time and date format, communication settings, print criteria, display contrast and brightness settings, and factory reset. Please review this entire section and the rest of the manual before making changes to the Analyzer. To gain access to any item in the menu, you can use the arrow buttons to scroll up and down and press **Enter** to highlight your selection. To exit the setup menu, press the **Display** button to return to a test or Test Menu to change the current test. A description of each menu item and procedure follows:

5.1 Lock Out

Selecting this entry, then setting Lock Out to ON locks out all changes from the Test Library and Analyzer Setup. You would use this function after the Analyzer has been put into operation, and you do not want to change any of the test or analyzer setup parameters. "LOCK OUT" is intended to protect against accidental menu changes.

ANALYZER SETUP
LOCK OUT
WEIGHT CAL
TEMP CAL
LANGUAGE
BEEPER
TIME-DATE

Press the **Setup** button. Using the arrow buttons, select LOCK OUT and press the **Enter** button.

LOCK OUT
LOCK OUT WILL LIMIT ACCESS TO MENUS AND SAVED SETTINGS / TESTS.
LOCK OUT: <input type="checkbox"/> OFF
EXIT WITHOUT SAVING

With LOCK OUT highlighted, use the arrow buttons to select either ON or OFF and press the **Enter** button. After selection, the display returns to ANALYZER SETUP menu.

5.2 Weight calibration

The Moisture Analyzer can be span calibrated with an external mass of 20 grams. Calibration of the Moisture Analyzer balance is not absolutely necessary for a correct moisture determination as the measurement is relative. The balance determines the weight of the sample before and after drying and the moisture is calculated on the basis of the ratio between wet and dry weights.

Nevertheless, you should calibrate the built-in balance under the following conditions:

- If this is stipulated by your quality assurance system (GLP, GMP, ISO 9001).
- If you suspect the analyzer has been abused.

To calibrate the Analyzer, proceed as follows:

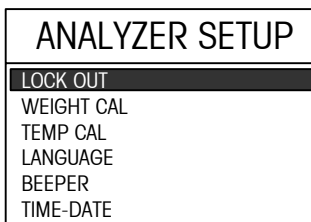

Clear the pan handler, a sample pan should be in place, close the cover on the Moisture Analyzer.

Press the **Setup** button. Using the arrow buttons, scroll to WEIGHT CAL. Press the **Enter** button.

The display screen highlights the action you should take.



Place the required weight on the sample pan, close the cover.

Follow the instructions on the display. The display indicates if the calibration was successful.

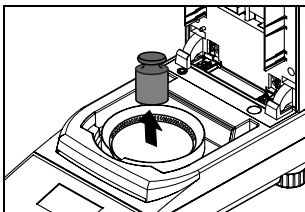
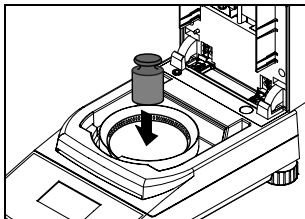

Press the **Display** button to return to display. To abort, press the **START/STOP** button.

5.3 Temperature Calibration

You must have a temperature calibration kit to perform this procedure. If the Moisture Analyzer has been recently used, allow at least 30 minutes before performing calibration.

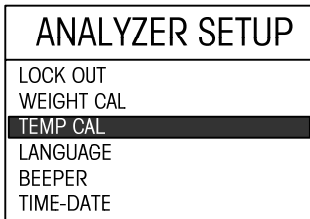

Note: The temperature calibration kit is available as optional equipment.

Press the **Setup** button. Using the arrow buttons, scroll to TEMP CAL. Press the **Enter** button. You are now prompted to remove the pan handler and pan support. Replace the pan handler and place a temperature calibration unit on the pan handler.



Note: The unit will not calibrate with the pan support in place.

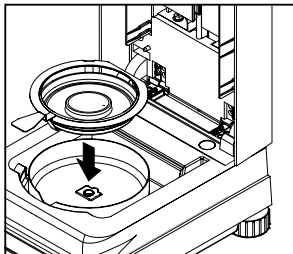

Press the **Enter** button to initiate the temperature calibration process. Follow the screen prompts throughout the process.

The dryer unit is heated to a temperature of 100°C. You can observe the progress on the display as the dryer temperature and count down period are displayed. After 15 minutes, read the thermometer through the inspection window on the cover and enter this temperature. Using the up/down arrow buttons, adjust the display reading to agree with the thermometer. Use the left/right arrow buttons to highlight ACCEPT NEW CAL, then press the **Enter** button. You have 10 minutes to make this adjustment, otherwise the calibration is terminated.

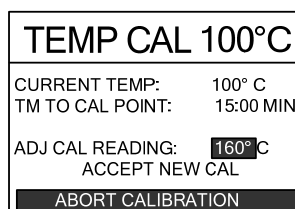
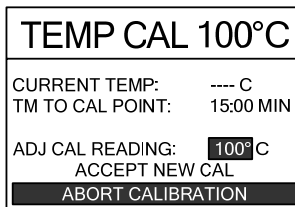

This is a two-point adjustment (100°C and 160°C). The dryer unit now heats to the second temperature (160°C). Adjustment of the temperature is defined by two points. Proceed exactly as you did for the first temperature. After you have set the display to agree with the thermometer, highlight ACCEPT NEW CAL, then press the **Enter** button. The display returns to ANALYZER SETUP.



WARNING: Be careful when removing the temperature calibration unit from the dryer unit as it can be very hot. Allow it to cool down by opening the cover before removing.

Remove the calibration unit. Replace the pan support and the pan handler in their proper positions.

5.4 Language setting

For convenience, the Moisture Analyzer is equipped with five languages available on all displays. This procedure permits the selection of any one language.

ANALYZER SETUP
LOCK OUT
WEIGHT CAL
TEMP CAL
LANGUAGE
BEEPER
TIME-DATE

Press the **Setup** button. Using the arrow buttons, select LANGUAGE.
Press the **Enter** button.

LANGUAGE
TEXT LANGUAGE
ENGLISH
EXIT WITHOUT SAVING

Using the arrow buttons, scroll to the desired language of either English, Deutsch, Espaniol, Francais or Italiano and press the **Enter** button.

Note: If you select English (US) as the dialog language, the date format is changed and appears on all records in the American notation (month/day/year).

5.5 Audible signal level

Certain processes are signalled by an audio signal (e.g. end of drying, entries, error messages, etc.). In this menu you can select whether the audio signal should be loud, soft or switched off.

ANALYZER SETUP
LOCK OUT
WEIGHT CAL
TEMP CAL
LANGUAGE
BEEPER
TIME-DATE

Press the **Setup** button. Using the arrow buttons, scroll to BEEPER.
Press the **Enter** button.

BEEPER LEVEL
AUDIO OUTPUT LEVEL
LOW
EXIT WITHOUT SAVING

Using the arrow buttons, scroll to the desired setting of either LOW, HIGH or OFF and press the **Enter** button. The display returns to ANALYZER SETUP menu.

5.6 Time and Date Setting

Your Moisture Analyzer has a communication output which allows printing the time and date on every record. When this instrument is put into operation for the first time, you should enter the current date and time. These settings are retained even if you disconnect your instrument from the power supply. A built-in battery will maintain all data. To set the time and date, proceed as follows:

ANALYZER SETUP	
LOCK OUT	
WEIGHT CAL	
TEMP CAL	
LANGUAGE	
BEEPER	
TIME-DATE	

Press the **Setup** button. Using the arrow buttons, select TIME-DATE.
Press the **Enter** button.

TIME - DATE	
FORMAT:	MM/DD/YR
SET DATE:	07/10/01
TIME FMT:	12HR
SET TIME:	11:30 AM
EXIT WITHOUT SAVING	

Format

FORMAT is highlighted. Select either MM/DD/YR or DD.MM.YR using the up/down arrow buttons.

TIME - DATE	
FORMAT:	MM/DD/YR
SET DATE:	07/10/01
TIME FMT:	12HR
SET TIME:	11:30 AM
EXIT WITHOUT SAVING	

Set date

Press the right arrow button, the highlighted area representing either month or days can be changed using the up/down arrow buttons. Enter the correct date. To advance to the next section of the date, use the right arrow button and up/down buttons to change. Repeat for the year.

TIME - DATE	
FORMAT:	MM/DD/YR
SET DATE:	07/10/01
TIME FMT:	12HR
SET TIME:	11:30 AM
EXIT WITHOUT SAVING	

Set time format

Press the right arrow button, 12HR is highlighted. Using the up/down arrow buttons, select either 12HR or 24HR.

TIME - DATE	
FORMAT:	MM/DD/YR
SET DATE:	07/10/01
TIME FMT:	12HR
SET TIME:	11:30 AM
EXIT WITHOUT SAVING	

Set time

Press the right arrow button, the hour portion of time format is highlighted. Using the up/down arrow buttons, enter the correct hour. Using the same procedure, enter minutes and AM or PM. Once you have completed entering time and date information, press the **Enter** button to save. The display returns to ANALYZER SETUP. If you do not want to save any changes, perform the next step.

TIME - DATE	
FORMAT:	MM/DD/YR
SET DATE:	07/10/01
TIME FMT:	12HR
SET TIME:	11:30 AM
EXIT WITHOUT SAVING	

Exit without saving

Using the right arrow button, advance to EXIT WITHOUT SAVING and press the **Enter** button. The display returns to ANALYZER SETUP.

5.7 RS232 settings

Your Moisture Analyzer is equipped with a bidirectional RS232 compatible interface for communication with printers and computers. When the Moisture Analyzer is connected directly to a printer, displayed data can be output at any time by simply pressing the **Print** button.

The following sections describe the hardware and software provided with the Moisture Analyzer.

ANALYZER SETUP	
WEIGHT CAL	
TEMP CAL	
LANGUAGE	
BEEPER	
TIME-DATE	
RS-232	

Press the **Setup** button. Using the down arrow button, scroll to RS232. Press the **Enter** button.

RS232	
BAUD RATE:	9600
PARITY:	NONE
DATA BITS:	8
STOP BITS:	1
HANDSHAKE:	NONE
EXIT WITHOUT SAVING	

Setting baud rate

Using the up/down arrow buttons, select the desired baud rates of 1200, 2400, 4800, 9600 or 19200. Default setting is 9600 baud.

RS232	
BAUD RATE	9600
PARITY	NONE
DATA BITS	8
STOP BITS	1
HANDSHAKE	NONE
EXIT WITHOUT SAVING	

Setting parity

Press the right arrow button to advance to PARITY. Using the up/down arrow buttons, select the desired parity setting of either NONE, EVEN or ODD. Default setting is NONE.

RS232	
BAUD RATE	9600
PARITY	NONE
DATA BITS	8
STOP BITS	1
HANDSHAKE	NONE
EXIT WITHOUT SAVING	

Setting data bits

Press the right arrow button to advance to DATA BITS. Using the up/down arrow buttons, select the desired data bits of 7 or 8. Default setting is 8.

RS232	
BAUD RATE	9600
PARITY	NONE
DATA BITS	8
STOP BITS	1
HANDSHAKE	NONE
EXIT WITHOUT SAVING	

Setting stop bits

Press the right arrow button to advance to STOP BITS. Using the up/down arrow buttons, select the desired stop bits of 1 or 2. Default setting is 1.

5.7 RS232 settings (cont)

RS232	
BAUD RATE	9600
PARITY	NONE
DATA BITS	8
STOP BITS	1
HANDSHAKE	NONE
EXIT WITHOUT SAVING	

Setting handshake

Press the right arrow button to advance to HANDSHAKE. Using the up/down arrow buttons, select the desired handshake of NONE, X ON-X OFF, or RTS-CTS. Default setting is NONE. Press **Enter** button to save, display advances to PRINT.

RS232	
BAUD RATE	9600
PARITY	NONE
DATA BITS	8
STOP BITS	1
HANDSHAKE	NONE
EXIT WITHOUT SAVING	

Exit without saving

Using the right arrow button, advance to EXIT WITHOUT SAVING and press the **Enter** button. The display returns to ANALYZER SETUP.

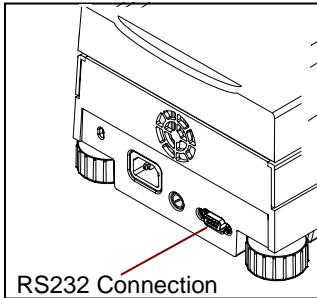

Hardware

On the rear of the Moisture Analyzer is a 9-pin female subminiature "D" connector provided for interfacing to other devices. Refer to the accessory list at the rear of this manual for a proper cable.

Section 9.2 illustrates the pinout connections on the RS232 connector.

5.8 Setting Print and GLP Printing On or Off

This menu permits setting print data and GLP printing data on or off. To set the printing functions, proceed as follows:

ANALYZER SETUP	
TEMP CAL	
LANGUAGE	
BEEPER	
TIME-DATE	
RS-232	
PRINT	

Press the **Setup** button. Using the down arrow button, scroll to PRINT. Press the **Enter** button.

PRINT	
PRINT:	<input type="checkbox"/> OFF
GLP:	<input type="checkbox"/> OFF
EXIT WITHOUT SAVING	

Setting print on or off

Using the up/down arrow buttons, select either ON or OFF. Print ON allows data to be sent to the printer or computer. Press the right arrow button to advance to GLP.

NOTE: If PRINT INT is turned in on TEST PARAMETER SETUP, the printer is automatically turned on.

PRINT	
PRINT:	<input type="checkbox"/> OFF
GLP:	<input checked="" type="checkbox"/> OFF
EXIT WITHOUT SAVING	

Setting GLP on or off

With GLP ON or OFF highlighted, use the up/down arrow buttons and select either ON or OFF. GLP ON will auto print in the GLP format from information in the Test Setup. GLP OFF sends time, temperature and weight data via RS232 at test Start, the Print Int and test End. Press the **Enter** button to save settings. The display returns to ANALYZER SETUP.

PRINT	
PRINT:	<input type="checkbox"/> OFF
GLP:	<input type="checkbox"/> OFF
EXIT WITHOUT SAVING	

Exit without saving

If you do not wish to save settings, Use the right arrow button and scroll to EXIT WITHOUT SAVING and press the **Enter** button. The display returns to ANALYZER SETUP.

5.9 Adjusting Display Contrast and Brightness

This menu permits adjusting the contrast and brightness levels on the display screen. To change the levels, proceed as follows:

ANALYZER SETUP	
LANGUAGE	
BEEPER	
TIME-DATE	
RS-232	
PRINT	
DISPLAY	

Press the **Setup** button. Using the down arrow button, scroll to DISPLAY.

Press the **Enter** button.

DISPLAY ADJUST	
CONTRA	60
ST:	10
BRIGHT:	
EXIT WITHOUT SAVING	

Adjusting contrast

Using the up/down arrow buttons, adjust the screen contrast to the desired level. The numeric value (0 to 100) is for reference only. Press the right arrow button to advance to BRIGHT. Default = 40.

DISPLAY ADJUST	
CONTRA	60
ST:	10
BRIGHT:	
EXIT WITHOUT SAVING	

Adjusting brightness

Using the up/down arrow buttons, adjust the screen brightness to the desired level. The numeric value (0 to 10) is for reference only. Press the **Enter** button. Default = 10.

DISPLAY ADJUST	
CONTRA	60
ST:	10
BRIGHT:	
EXIT WITHOUT SAVING	

Exit without saving

If you do not wish to save settings, Use the right arrow button and scroll to EXIT WITHOUT SAVING and press the **Enter** button. The display returns to ANALYZER SETUP.

5.10 Factory reset

ANALYZER SETUP
BEEPER
TIME-DATE
RS-232
PRINT
DISPLAY
FACT.RESET

Factory reset

Press the **Setup** button. Using the down arrow button, scroll to FACT. RESET and press **Enter**.

FACTORY RESET
RESET UNIT TO FACTORY SETTINGS. SAVED LIBRY TEST WILL NOT BE LOST. RESET: <input type="button" value="NO"/>

Using the up/down arrow buttons, select NO or YES. If you select YES, the prompt asks: (ARE YOU SURE) (NO) (YES). Press the **Enter** button.

Factory reset settings

The following table indicates the menus and options which are factory default settings when Factory Reset is set to YES.

FACTORY RESET TABLE

Menu Items	Default Value
Analyzer Setup Menu	
Lock Out	OFF
Custom Unit	1.000,0,1
Language Setting	English
Beeper	Low
Time-Date	MM/DD/YY
RS232 Setting	9600, N, 8, 1, None
Print Settings	Print OFF, GLP OFF
Display	60, 10
Factory Reset	NO

6. Operating Your Moisture Analyzer

This section contains information on the use of the Test Menu which will enable you to set the actual drying parameters such as Profile, Switch-Off, Display, Print Intervals, Target Weight and the use of the library.

6.1 The operating concept

You have already set the Moisture Analyzer setup in Section 5 and have tried the simple moisture determination in Section 3. You are now ready to perform moisture determinations in a precise manner. The test menu shown in Section 4 offers a number of setting possibilities to match the measurement process to your specific requirements. For instance, you can select the drying temperature, type of display and many other parameters.

Please keep in mind the importance of preparing your sample, the distribution of the sample on the weighing pan, the type of sample and the temperature range. Remember, the greater the number of uniform samples tested, the greater the accuracy of the results. Before starting your test, refer to Appendix A for Application Examples. There is a table which describes various sample types, sample weights, temperature programs and drying temperatures. You will find this reference table very helpful in establishing test criteria. Please review this entire section before actually making any settings to become familiar with the instrument.

6.2 Entering test ID

The TEST ID enables you to specify a name or date to identify the test, Up to nine alphanumeric characters may be entered. If an entry is not made, a default of the current date followed by A is automatically made. If subsequent tests are made and entries to the TEST ID are disregarded, the current date is again displayed followed by B, C etc.

TEST LIBRARY	
-EDIT TEST-	
01	
02	
03	
04	
05	

Press the **Test Menu** button, TEST LIBRARY is displayed. The test library is referred to in Section 7. Complete information on how to use the library is covered in this section.

When starting a new test, EDIT TEST is displayed. Press the **Enter** button. The screen will change to TEST PARAMETERS.

TEST PARAMETERS	
TEST ID:	-DEFAULT-
PROFILE:	STANDARD
DRY TEMP:	180C
SWITCH OFF:	AUTO 60
RESULT:	MOISTURE%
CUSTOM:	OFF

TEST ID DEFAULT is displayed when no tests have been entered, otherwise, the last test appears and can be changed to a new test. Press the **Enter** button.

TEST ID
DEFAULT = 071000 A

EXIT WITHOUT SAVING

Using the arrow buttons, enter either a test name or identifying number and press the **Enter** button. The display returns to TEST SETUP.

6.3 Setting the drying profile

The drying profile contains four settings, Standard, Fast, Ramp and Step. Section 6, paragraph 6.4 describes each of the drying profiles. Review the profile descriptions. Depending upon the sample material to be analyzed, select the appropriate profile and proceed as follows:

TEST PARAMETERS	
TEST ID:	-DEFAULT-
PROFILE:	STANDARD
DRY TEMP:	180C
SWITCH OFF:	AUTO 60
RESULT:	MOISTURE%
CUSTOM:	OFF

Standard Profile

Using the arrow buttons, scroll to PROFILE and press the **Enter** button.

DRYING PROFILE	
STANDARD	
EXIT WITHOUT SAVING	

Using the arrow buttons, scroll to STANDARD and press **Enter** button.

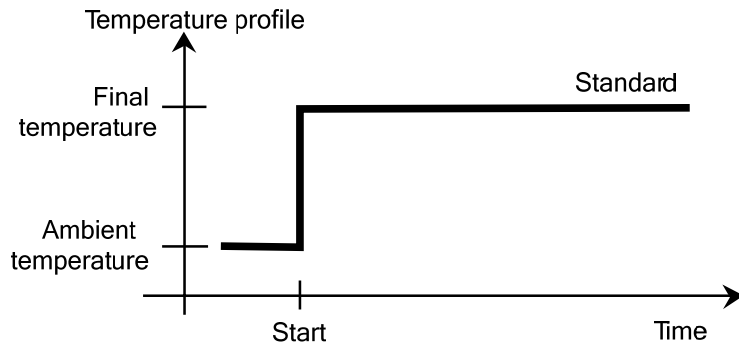

TEST PARAMETERS	
TEST ID:	-DEFAULT-
PROFILE:	STANDARD
DRY TEMP:	180C
SWITCH OFF:	AUTO 60
RESULT:	MOISTURE%
CUSTOM:	OFF

Fast Profile

Using the arrow buttons, scroll to PROFILE and press the **Enter** button.

DRYING PROFILE	
FAST	
EXIT WITHOUT SAVING	

Using the arrow buttons, scroll to FAST and press the **Enter** button.

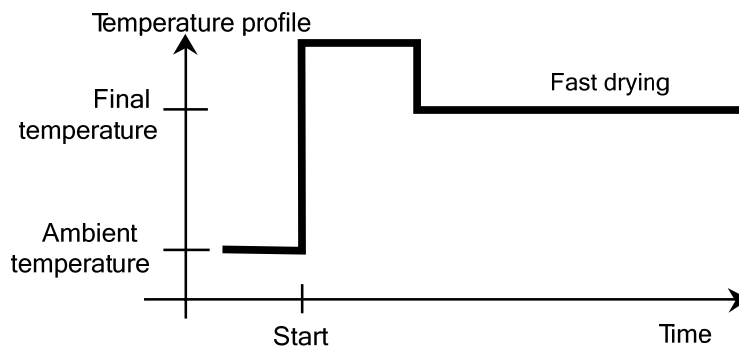

6.3 Setting the drying profile (cont)

TEST PARAMETERS	
TEST ID:	-DEFAULT-
PROFILE:	STANDARD
DRY TEMP:	180C
SWITCH OFF:	AUTO 60
RESULT:	MOISTURE%
CUSTOM:	OFF

Ramp Profile

For this temperature program, the temperature and time elapsed between the start of drying and the attainment of the final temperature is set.

Using the arrow buttons, scroll to PROFILE and press the **Enter** button.

DRYING PROFILE	
RAMP	
EXIT WITHOUT SAVING	

Using the arrow buttons, scroll to RAMP and press the **Enter** button.

RAMP PROFILE	
END TEMP:	50 C
RAMP TIME:	3 MIN
EXIT WITHOUT SAVING	

Enter the desired temperature using the arrow buttons.

RAMP PROFILE	
END TEMP:	50 C
RAMP TIME:	3 MIN
EXIT WITHOUT SAVING	

Using the arrow buttons, scroll to RAMP TIME. Enter the desired ramp time using the arrow buttons and press the **Enter** button.

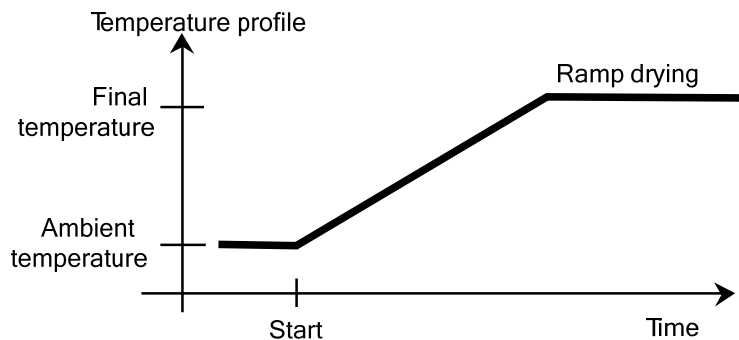

TEST PARAMETERS	
TEST ID:	-DEFAULT-
PROFILE:	STANDARD
DRY TEMP:	180C
SWITCH OFF:	AUTO 60
RESULT:	MOISTURE%
CUSTOM:	OFF

Step Profile

For this temperature program you define the temperature and the hold time for each step.

Using the arrow buttons, scroll to PROFILE and press the **Enter** button.

DRYING PROFILE	
STEP	
EXIT WITHOUT SAVING	

Using the arrow buttons, scroll to STEP and press the **Enter** button.

6.3 Setting the drying profile (cont)

RAMP PROFILE		
STEP 1:	80 C	5 MIN
STEP 2:	100 C	5 MIN
FINAL:	130 C	
EXIT WITHOUT SAVING		

For STEP 1, using the arrow buttons, define the temperature. Using the arrow buttons, scroll to time.

Using the arrow buttons, define the time.

Repeat the above procedure for step 2 and FINAL step and press the **Enter** button.

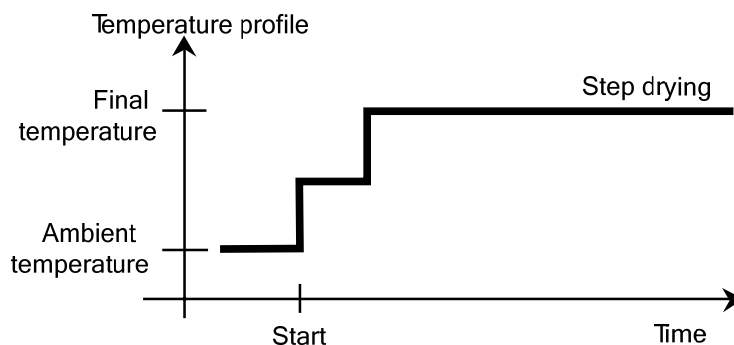

6.4 Setting the drying temperature

The drying temperature can be set from 50°C to 200°C. Two of the programs under TEST PARAMETERS - PROFILE (Standard and Fast) use this temperature setting.

TEST PARAMETERS	
TEST ID:	-DEFAULT-
PROFILE:	STANDARD
DRY TEMP:	180C
SWITCH OFF:	AUTO 60
RESULT:	MOISTURE%
CUSTOM:	OFF

Using the arrow buttons, scroll to DRY TEMP and press the **Enter** button.

DRYING TEMP
130 C
EXIT WITHOUT SAVING

Using the arrow buttons, enter the desired drying temperature and press the **Enter** button.

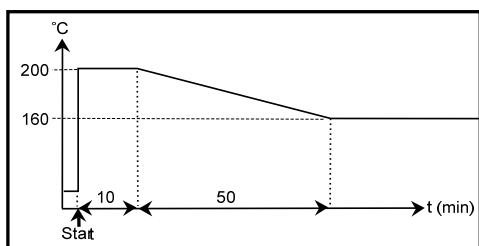

Temperature limitation

The following protective measures have been implemented to protect the instrument against overheating:

- The Moisture Analyzer is equipped with an overheating protection.
- At temperatures above 160C, a time limit becomes active. The higher the temperature, the shorter the time until the instrument starts to lower the temperature (envelope curve, see adjacent illustration).

Note: If you are working at temperatures above 180C, we advise you to wait 2 to 3 minutes with open instrument lid between individual measurements to ensure good reproducibility and avoid overheating of the instrument.

6.5 Selecting the switch-off criterion

This menu offers you different switch-off criterion. Switch-off criterion defines when the instrument should end the drying. Switch-off criterion eliminates checking your watch or clock and stopping the drying manually. Review the list below and select one criterion that suits your purpose.

The following settings can be selected for the switch-off criterion:

- Manual switch-off
- Timed switch-off
- Auto switch-off (weight loss per unit of time - 3 settings)
- Auto free switch-off (user-defined mean weight loss per unit of time)

TEST PARAMETERS	
TEST ID:	-DEFAULT-
PROFILE:	STANDARD
DRY TEMP:	125C
SWITCH OFF:	MANUAL
RESULT:	MOISTURE%
CUSTOM:	OFF

Manual

With this switch-off criterion selected, the measurement process continues until you stop it with the **Stop** button.

Using the arrow buttons, scroll to SWITCH OFF and press the **Enter** button.

SWITCH OFF
MANL - USE START/STOP
EXIT WITHOUT SAVING

Using the arrow buttons, scroll to MANL - USE START/STOP and press the **Enter** button.

TEST PARAMETERS	
TEST ID:	-DEFAULT-
PROFILE:	STANDARD
DRY TEMP:	125C
SWITCH OFF:	TIMED 20.00
RESULT:	MOISTURE%
CUSTOM:	OFF

Timed switch-off

With this switch-off criterion selected, the measurement lasts until the preset drying time has elapsed (the display provides you with continuous information on the drying time).

Using the arrow buttons, scroll to SWITCH OFF and press the **Enter** button.

SWITCH OFF
TIMED - SWITCH OFF
EXIT WITHOUT SAVING

Using the arrow buttons, scroll to TIMED - SWITCH OFF and press the **Enter** button.

TIMED SWITCH-OFF
20:00MIN
EXIT WITHOUT SAVING

Using the arrow buttons, enter the desired drying time and press the **Enter** button.

Auto switch-off

The switch-off criterion is based on a *weight loss per unit of time*. As soon as the mean weight loss is less than a preset value during a specified time, the instrument considers drying as complete and automatically discontinues the measurement process. During drying, the display indicates the elapsed time of the drying process; the switch-off criterion is inactive during the first 30 seconds.

The automatic switch-off criterion is divided into three selectable levels:

- **A30:** Less than 1mg loss in 30 seconds, used for samples which dry very quickly (surface moisture) or for (relatively inaccurate) fast measurements to determine a trend.
- **A60:** Less than 1mg loss in 60 seconds, used for most types of samples.
- **A90:** Less than 1mg loss in 90 seconds, used for slow drying substances (trapped moisture, skin formation).

Select the criterion for your measurements.

TEST PARAMETERS	
TEST ID:	-DEFAULT-
PROFILE:	STANDARD
DRY TEMP:	125C
SWITCH OFF:	AUTO60
RESULT:	MOISTURE%
CUSTOM:	OFF

Using the arrow buttons, scroll to SWITCH OFF and press the **Enter** button.

SWITCH OFF
A30 - <1MG IN 30 SEC
EXIT WITHOUT SAVING

Using the arrow buttons, scroll to either A30 <1MG IN 30 SEC, A60 <1MG IN 60 SEC or A90 < 1MG IN 90 SEC and press the **Enter** button.

Auto free switch-off

Auto free switch-off criterion is based on a user defined mean weight loss per unit of time. If none of the three switch-off criteria "Weight loss per unit of time" is suitable for your application, the Moisture Analyzer allows you to define a free switch-off criterion. The free switch-off criterion is also based on the principle of the mean weight loss per unit of time. As soon as this drops below the preset value, the measurement is automatically ended.

TEST PARAMETERS	
TEST ID:	-DEFAULT-
PROFILE:	STANDARD
DRY TEMP:	125C
SWITCH OFF:	AFREE
RESULT:	MOISTURE%
CUSTOM:	OFF

Using the arrow buttons, scroll to SWITCH OFF and press the **Enter** button.

SWITCH OFF
AFREE - WT LOSS / TIME
EXIT WITHOUT SAVING

Using the arrow buttons, scroll to AFREE -WT LOSS/TIME and press the **Enter** button.

Auto free switch-off (cont)

AUTO FREE	
SWITCH OFF AT LESS THAN	
5	MG IN 60 SECONDS
EXIT WITHOUT SAVING	

Using the arrow buttons, scroll to MG, now enter the weight loss (1 mg to 10 mg).

AUTO FREE	
SWITCH OFF AT LESS THAN	
5 MG IN	60
SECONDS	
EXIT WITHOUT SAVING	

Using the arrow buttons, enter the time (10 seconds to 120 seconds). Press the **Enter** button.

6.6 Result

Displayed result offers you the choice of whether your display indicates % moisture, % solids, % regain, grams or custom unit during the measurement process.

TEST PARAMETERS	
TEST ID:	-DEFAULT-
PROFILE:	STANDARD
DRY TEMP:	125C
SWITCH OFF:	AFREE
RESULT:	MOISTURE%
CUSTOM:	OFF

Using the arrow buttons, scroll to RESULT and press the **Enter** button.

TEST PARAMETERS	
% MOISTURE	
EXIT WITHOUT SAVING	

Using the arrow buttons, scroll to either % MOISTURE, % SOLIDS, % REGAIN, GRAMS or CUSTOM UNITS and press the **Enter** button.

- NOTES:**
1. If you change the displayed result during a test, the final result and the printed results will be in displayed units.
 2. When CUSTOM is selected, the parameters for custom units are changed in paragraph 6.7.

6.7 Custom units

Custom unit allows the creation of your own custom weighing unit. It permits entering a conversion factor which the Moisture Analyzer will use to convert grams to the desired unit of measure. The custom unit is available under the Test Parameters menu, Display settings. When the Moisture Analyzer is completely set up and running a test, you have the option under the Display to view % Moisture, % Solids, % Regain, Grams or Custom Unit.

$$\text{Conversion Factor} \times \text{Weight in grams} = \text{Weight in custom unit}$$

Conversion factors are expressed in scientific notation and entered into the balance in three parts:

1. a number between 0.1 and 1.999999 called the mantissa
2. a power of 10 called the exponent
3. a least significant digit (LSD)

SCIENTIFIC NOTATION				
Conv. Factor	Number Between 0.1 and 1.999999	Power of 10	Mantissa	Exp.
123.4	= .1234	x 1000	= .1234	x 10 ³
12.34	= .1234	x 100	= .1234	x 10 ²
1.234	= .1234	x 10	= .1234	x 10 ¹
.1234	= .1234	x 1	= .1234	x 10 ⁰
.01234	= .1234	x .1	= .1234	x 10 ⁻¹
.001234	= .1234	x .01	= .1234	x 10 ⁻²
.000123	= .123	x .001	= .123	x 10 ⁻³

EXPONENTS	
-3	Moves decimal point 3 places to the left.
-2	Moves decimal point 2 places to the left.
-1	Moves decimal point 1 place to the left.
0	Leaves decimal point in normal position.
1	Moves decimal point 1 place to the right.
2	Moves decimal point 2 places to the right.
3	Moves decimal point 3 places to the right.

TEST PARAMETERS
TEST ID:
PROFILE:
DRY TEMP:
SWITCH OFF:
RESULT:
CUSTOM:

To create a custom unit, proceed as follows:

Press the **Test Menu** button, EDIT TEST is highlighted.

Press the **Enter** button, TEST PARAMETERS screen is displayed with TEST ID highlighted.

TEST PARAMETERS
TEST ID:
PROFILE:
DRY TEMP:
SWITCH OFF:
RESULT:
CUSTOM:

Custom unit

Using the down arrow button, scroll to RESULT and press the **Enter** button.

DISPLAYED RESULT
CUSTOM UNITS
EXIT WITHOUT SAVING

Displayed result setting

Using the up/down arrow buttons, select CUSTOM UNITS and press the **Enter** button. The screen returns to TEST SETUP.

6.8 Custom units (cont)

TEST SETUP	
TEST ID:	
PROFILE:	
DRY TEMP:	
SWITCH OFF:	
RESULT:	CUSTOM
CUSTOM:	1.00000

Custom unit

With CUSTOM highlighted, press the **Enter** button.

CUSTOM UNIT	
FACTOR	+ 1.00000
EXPONENT	0
LSD	1
EXIT WITHOUT SAVING	

Factor

Using the arrow buttons, enter the factor number. This can be a number between 0.1 and 1.999999. For conversion factors outside of this range, the exponent will be used to move the decimal point. Press the right arrow button to advance to EXPONENT.

CUSTOM UNIT	
FACTOR	1.00000
EXPONENT	0
LSD	1
EXIT WITHOUT SAVING	

Exponent

Using the up/down arrow buttons, select an exponent either +3, +2, +1, 0, -1, -2, or -3. Press the right arrow button to advance to LSD.

CUSTOM UNIT	
FACTOR	1.00000
EXPONENT	0
LSD	1
EXIT WITHOUT SAVING	

LSD

Using the up/down arrow buttons, select the least significant digit (LSD) of 1, 2, 5, 10 or 100 and press the **Enter** button. The display returns to the TEST SETUP screen.

6.9 Target Weight

Target weight is used when previous samples have been tested and the target weight is known. Target weight is a reminder to use a consistent sample size.

TEST PARAMETERS	
DRY TEMP:	125C
SWITCH OFF:	AFREE
RESULT:	CUSTOM
CUSTOM:	1.00000
TARG. WGT:	5 GRAMS
PRINT INT:	OFF

Using the arrow buttons, scroll to TARG. WGT and press the **Enter** button.

TARGET WEIGHT
RECOMEND SAMP WGT
5 GRAMS
EXIT WITHOUT SAVING

Using the arrow buttons, define the target weight and press the **Enter** button.

6.10 Print interval

When the printing option has been turned on in the Analyzer Setup menu and an external printer is connected to the Moisture Analyzer, you have the option of selecting discrete printing intervals of OFF, 1, 3, 5, 10, 30 seconds, or 1, 2, 5 minutes. To select a printing interval, proceed as follows:

TEST PARAMETERS	
DRY TEMP:	125C
SWITCH OFF:	AFREE
RESULT:	CUSTOM
CUSTOM:	1.00000
TARG. WGT:	5 GRAMS
PRINT INT:	5 SECOND

Using the arrow buttons, scroll to PRINT INT and press the **Enter** button.

PRINT INTERVAL
SECONDS
5
EXIT WITHOUT SAVING

Using the arrow buttons, select the desired print interval of either seconds or minutes and press the **Enter** button.

6.11 Saving Test Setup

Saving test setup saves all of the test parameters you have entered for the sample undergoing measurement. You have the option of saving or not saving the data. When saved, the test parameters are stored in the Library. If you want to exit without saving, see paragraph 6.11.

TEST PARAMETERS	
SWITCH OFF:	AFREE
RESULT:	CUSTOM
CUSTOM:	1.00000
TARG. WGT:	5 GRAMS
PRINT INT:	5 SECOND
SAVE TEST:	

Using the arrow buttons, scroll to SAVE TEST and press the **Enter** button.

TEST 071000 B
SAVE TO TEST LIBRARY YES LIBRARY # 1

Using the arrow buttons, select YES or NO and press the **Enter** button.

TEST 071000 B
SAVE TO TEST LIBRARY YES LIBRARY # 1

Using the arrow buttons, select the library number and press the **Enter** button. If the library number has been previously assigned, you can overwrite the data. To prevent this, a screen with "OK TO OVERWRITE", is displayed and you have the choice to select YES or NO.

TEST 071000 B
SAVE TO TEST LIBRARY YES LIBRARY # 1 OK TO OVERWRITE? NO

Press the **Display** button to return to main display.

6.11 Exiting test setup and not saving changes

When you want to exit any of the test setup procedures, you would press the **Display** button. This action will ignore all entries made and bring you back to the first screen in Test Menu. You can continue to do this if a number of tests have to be entered and not run at this time.

6.12 Running the test setup

Running the test setup takes all of the test parameters you have entered for the sample undergoing measurement and initiates the test. Once all of the parameters have been entered, the main display automatically indicates the test parameters and the test is ready to run.

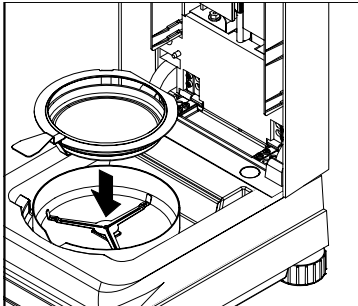

Follow the instructions on the lower left side of the screen.

Place the empty sample pan in the pan handler (this is possible without tilting the sample pan if you insert this in the pan handler from the side directly below the round flange). Place the pan handler in the sample chamber. Ensure that the tongue of the pan handler fits exactly in the slot of the draft shield element. The sample pan must lie flat in the pan handler.

Note: It is advisable for you to work with the pan handler at all times. The pan handler is ergonomic, safe and provides protection against possible burns due to a hot sample pan.

TEST ID:	071000 B
TEMP/TIME:	130°C / AFREE
TARG. WGT:	5 GRAMS
CLEAR PAN PRESS TARE	0.000 * GRAMS

The display indicates instructions to process the sample. Clear the pan.



Press the **Tare** button. This sets the Moisture Analyzer to zero. A new display now appears with instructions.

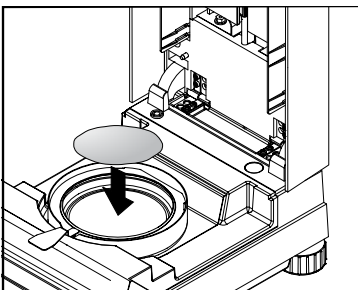

Add the sample and process as shown in the illustrations.

Place the specimen sample in the sample pan.

TEST ID:	071000 B
TEMP/TIME:	130°C / AFREE
TARG. WGT:	5 GRAMS
ADD SAMPLE CLOSE COVER	0.000 * GRAMS

Close the cover.



Starting the test

Press the **Start/Stop** button. The Moisture Analyzer starts the drying and measurement process. All of the settings made in the Test Menu are now put into effect.

TEST ID:	071000 B
TEMP/TIME:	130°C / AFREE
INITIAL WT:	1.094 G
130°C	2.14%
1:10	MOISTURE

A running real time display illustrates the drying process which includes the test ID, set temperature, type of switch off, initial weight, current temperature in the chamber, actual elapsed time of the test, and moisture content.

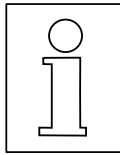

Interrupting the test (manual switchoff only)

During the measurement process, the test can be interrupted for a very short period of time if a sample has to be stirred for example. To do this, simply lift the cover, stir the sample and close the cover. The test will resume. In the PRINT MODE, the time the cover is open will be printed.



Remember, use caution as components are hot.

Stopping the test

Press the **Start/Stop** button. The Moisture Analyzer stops the drying and measurement process.

Removing the sample

When the test measurement is completed, you may remove the sample from the instrument by opening the cover, and carefully lift the pan handler from the chamber.

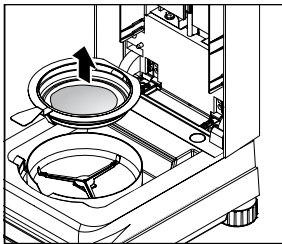

6.13 Displaying data during run mode or after completion

To display the various screens, press the **Display** button repeatedly.

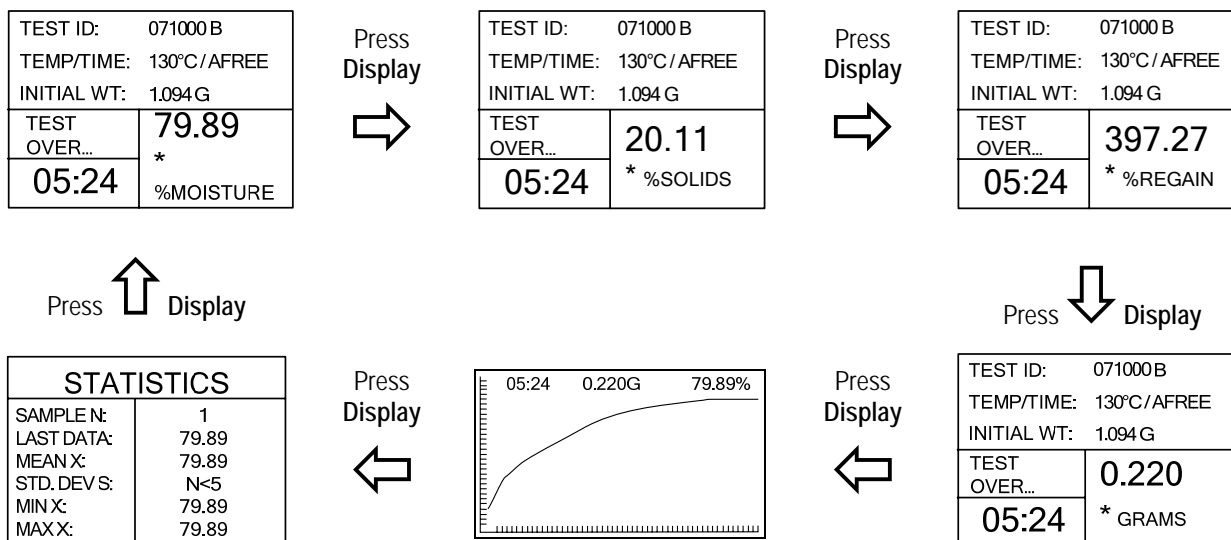

6.14 Statistical data

The STATISTICS screen is shown when repeatedly pressing the **Display** button during a test or at the end of a test. The screen displays rolling statistics information on data points entered. Statistical data is kept in the same units as results. Data points are entered at the end of a test by pressing the **Enter** button while the STATISTICS screen is displayed. No deviation is shown for less than 5 samples. There is one statistical screen kept in the Library for each test and the current test. This allows for a total of fifty-one (51), fifty (50) stored and (1) active, distinct sets of statistics. Statistical data can be accumulated each time a given test is run.

Printing statistical data

To print statistical data, press and hold the **Print** and **^** arrows simultaneously. See section 9 for printing sample.

Clearing statistical data

To clear all statistical data from a test, press the **<** and **>** arrow buttons simultaneously.

Starting a new test

To exit and start a new test, press the **Tare** button when the STATISTICS screen is displayed.

7. Using the Library

The library holds up to 50 tests. Each test consists of a test name and various analyzer settings, which may be stored, recalled and edited. Each time the Moisture Analyzer is set up to run a new test, the name of the test and all parameters are automatically stored in the library. When the 51st test is entered, it can be run, but will not be stored. When the library capacity is exceeded and you want to store a new test, you must delete a previous test. Recalling a test from the library and pressing the **Enter** button initiates the same parameters previously set. If the parameters for a given test have changed, they can be changed by using the edit function. To use the library function, proceed as follows:

TEST LIBRARY
-EDIT TEST-
01 BUTTER
02 OREO
03 MARGARINE
04 TOBLERONE
05

Entering the library

Press the **Test Menu** button, TEST LIBRARY is displayed. EDIT TEST is highlighted. If the instrument is being used for the first time, the library will be empty. The following examples indicate a library which has multiple tests stored.

TEST LIBRARY
-EDIT TEST-
01 BUTTER
02 OREO
03 MARGARINE
04 TOBLERONE
05

Selecting a previous test

To select a previous test, use the arrow buttons and scroll to the desired test and press the **Enter** button. A new screen with the name of the test is displayed. All of the parameters associated with the test selected are now available to be run again. You do not have to enter any new data.

TEST LIBRARY
LOAD TEST
EXIT TO LIBRARY

Running a previous test

Using the arrow buttons, select LOAD TEST and press the **Enter** button. The display returns to the Test Library. To run the selected test, press the **Display** button and follow instructions on the display.

TEST LIBRARY
-EDIT TEST-
01 BUTTER
02 OREO
03 MARGARINE
04 TOBLERONE
05

Editing a previous test

Enter the Test Library. Using the arrow buttons, scroll to the test you want to edit. Press the **Enter** button, LOAD TEST is displayed. Scroll back to EDIT TEST and press the **Enter** button. The test you have selected can now be edited. When completing the editing, scroll down to SAVE TEST and press the **Enter** button.

TEST LIBRARY
-EDIT TEST-
01 BUTTER
02 OREO
03 MARGARINE
04 TOBLERONE
05

Deleting a previous test

Press **Test Menu** button, TEST LIBRARY is displayed. Using the arrow buttons, scroll to the test you want to delete. Press the **Enter** button, LOAD TEST is displayed. Press the up arrow button, DELETE TEST is displayed, press the **Enter** button. ARE YOU SURE? is highlighted, using the arrow buttons, select YES and press the **Enter** button.

8. How to obtain the best results

Following your first practical work with the Moisture Analyzer, in this section you will find important information on how to obtain optimum results. You will learn what parameters influence the measurement process and how you can match the instrument optimally to your particular measurement test.

8.1 Measurement principle of the Halogen Moisture Analyzer

Your instrument performs measurements based on the **thermogravimetric principle**, i.e. the moisture is determined from the weight loss of a sample dried by heating.

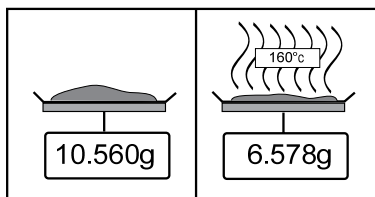

The Ohaus Moisture Analyzer comprises two instruments: a precision balance and a dryer unit. In contrast to other thermogravimetric methods (drying oven, infrared, microwave), the Halogen Moisture Analyzer operates with a halogen dryer unit. This ensures fast heating of the sample and thus guarantees rapid availability of the measurement results.

In addition to thermogravimetric methods, chemical and electrical methods for moisture determination are also common. A familiar chemical method is Karl Fischer in which the water content is determined by titration. This method is particularly suitable for determination of the water content of liquids or for the detection of very small amounts of water (ppm range) in solid and liquid samples.

Regardless of the measurement method used, the quality of the measurement stands or falls by the **preparation of the sample** and **a correct choice of the important measurement parameters:**

- Sample size
- Type of sample
- Drying temperature
- Drying time

In practice, however, not only the quality of the measurement results, but also the **speed of the measurement process** is important. Thanks to its drying principle (with the heat generated by a halogen radiator), the Halogen Moisture Analyzer is very fast. The drying speed can even be increased further through optimum settings of the instrument.

The **optimum drying temperature and the drying time** are dependent upon the nature and size of the sample and the desired accuracy of the measurement results. **These can be determined only by experiment.**

8.2 Sampling and sample preparation

Characteristics, preparation and size of the sample are all important contributing factors in increasing speed and the quality of the measurement process.

Sampling and the sample preparation have a great influence on the reproducibility of the measured results. It is also important that the sample being investigated is a representative part of the total amount of the sample under test.

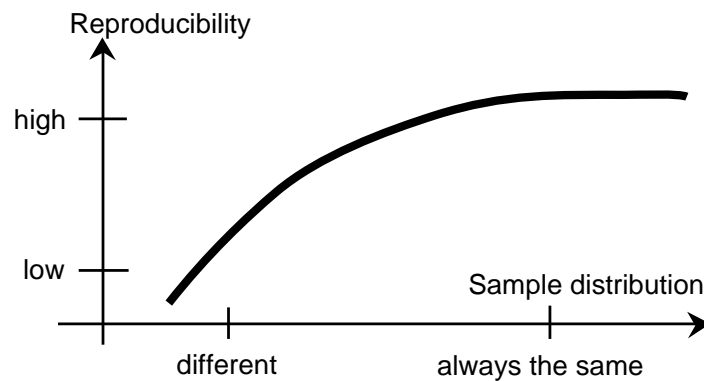

The final results of a moisture determination depends on a carefully thought out sample preparation. The part of the sample used for analysis must always be representative of the total quantity. The sample preparation includes work processes such as sampling, sample division, size reduction, homogenization and others. All of these processes should be carried out as quickly as possible and without loss or uptake of moisture.

As with most products, the lab samples are not homogenous. As a result, random sampling will not lead to a representative sample. The appropriate standards and directions must be consulted to determine the method of sampling as this is dependent upon the product, consistency and the amount used.

Number of samples

An increase in the number of samples always lead to an improvement in the statistical reliability of the analysis results. The size depends on the homogeneity of the test material, the accuracy of the test material, the accuracy of the measurement method and the desired accuracy of the measurement result.

Mechanical size reduction

Sample division is usually accomplished by specific types of mills influenced by the sample characteristics. Hard, brittle samples are mainly reduced in size by pressure, impact or friction action, whereas, soft and viscoplastic substances can be comminuted only by shearing or cutting action. Whatever the operating principle of a mill may be, for the subsequent moisture determination, there must be no loss of moisture during the milling operation. If this can not be avoided, it should at least be calculable. The quantitative recovery of the mill chamber should also be simple and complete.

8.2 Sampling and sample preparation (cont)

Use of quartz sand

To ensure an optimum drying process, samples should always have as large an area as possible. Results of substances which form crusts (e.g. glucose syrup) or pasty substances (e.g. butter) can be considerably improved by mixing with quartz sand. Sample pans with a large volume and relatively high walls are needed for this.

Pasty, fat-containing and melting substances

For pasty, fat containing and melting substances, use of a glass fiber filter is advantageous to increase the surface area of the sample. The glass fiber filter is tared together with the sample pan. The liquid contained in the substance is uniformly and extensively distributed in the interstices between the fibers throughout the available area. The same also applies to melting fats and fat containing samples. This increase in the surface area results in faster and complete vaporization of the moisture. Pre-drying of the glass fiber filter and storage in a desiccator is necessary only for highly precise measurement results.

Liquid substances

Liquid substances (e.g. dispersions) often tend to form drops on the sample pan owing to the surface tension of the liquid. This prevents a rapid drying process. The use of a commercial glass fiber filter shortens the drying time by a factor of 2 to 3. The glass fiber filter distributes the liquid sample over a wide area as a result of its absorbent action. Pre-drying of the glass fiber filter and storage in a desiccator is necessary only for highly precise measurement results.

Skin-forming and temperature sensitive substances

The use of a glass fiber filter can be useful for temperature-sensitive and skin forming substances. In this case, the sample to be dried is covered by the filter and thus receives a "new surface". This shields the surface of the sample against direct IR radiation. Gentler heating of the samples is based on convection rather than on IR radiation. Experience with this type of preparation has been good; particularly for products containing sugar. Further, the shielding of the sample against direct IR radiation by covering the test substance can make a considerable contribution to improving the reproducibility with temperature sensitive samples.

Sugar-containing substances

Samples containing a large amount of sugar tend to caramelize on the surface. In such cases, ensure a thin layer is applied. Also select a moderate temperature.

Sample application on the drying pan

To obtain reproducible results, it is essential to ensure uniform distribution of the sample on the pan. An uneven distribution can result in homogeneous heat distribution in the sample. As a result, the sample could be incompletely dried in the center owing to excessive piling. Thick layers have an adverse effect on the escape of moisture. The resulting lengthening of the measurement time promotes decomposition at the surface of the sample by prolonged heat action.

Film formation on the sample can prevent complete escape of the moisture. With such samples, ensure application of a thin and uniform layer thickness.

8.2 Sampling and sample Preparation (Cont).

With readily volatile samples, rapid application of the sample on the sample pan is advisable, otherwise, moisture can escape before the initial weight is recorded; here, use of the manual operating mode is appropriate.

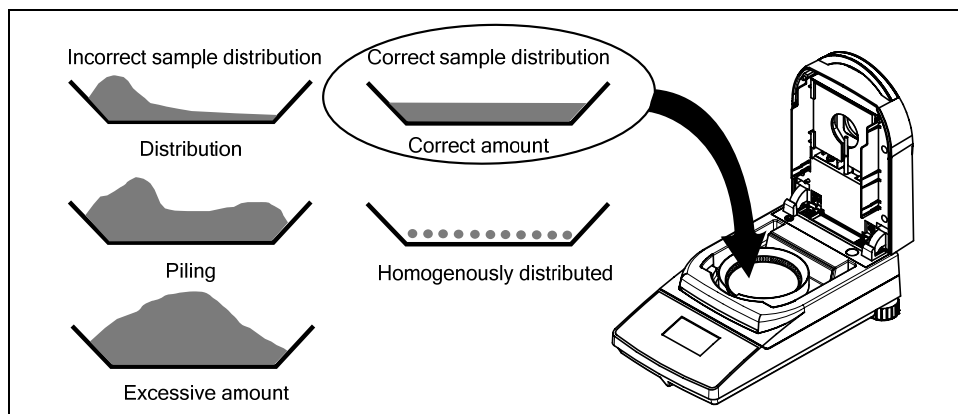

Treating the sample during drying

Occasionally, following recording of the initial weight of the sample and before the actual drying, the test substance is subjected to further treatment. The halogen Moisture Analyzer from OHAUS offers this possibility in the "manual" operating mode.

Such applications could include:

- Mixing of quartz sand: moisture which vaporizes during the mixing of the sample is correctly taken into account in the final result.
- Coagulation of protein by dropwise addition of alcoholic solutions. This prevents skin formation during drying. Added solvent is not recorded in the final result.
- Formation of readily volatile azeotropes by addition of solvents insoluble in water (e.g. xylene, toluene).

Note that the addition of solvents can lead to the formation of flammable or even explosive mixtures. With applications of this type, you should thus work with extremely small amounts of samples and with the necessary care. In cases of doubt, a careful risk analysis must be performed.

Selection of the optimum sample weight

The sample weight has an influence on both the accuracy of the measurement results and the measurement time. With large amounts of samples, a great deal of water must vaporize and the moisture determination takes longer.

To keep the measurement time as short as possible, we advise you choose a low weight for your sample, but not so low that attainment of the required measurement accuracy is no longer possible.

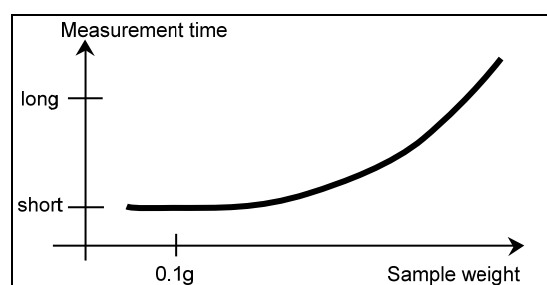
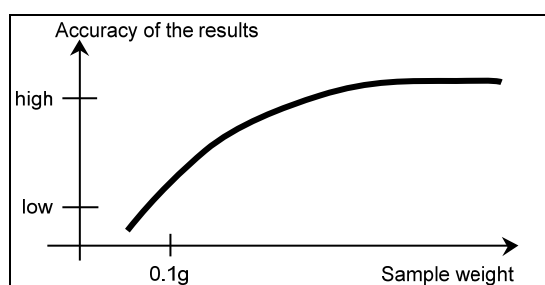

Influence of the sample weight on the repeatability of the results

Sample weight influences the repeatability of the Moisture Analyzer. The repeatability always becomes worse with decreasing sample weight. The relation between sample weight and repeatability is shown in the following table:

Sample weight	Repeatability
0.5g	±0.6%
1g	±0.3%
2g	±0.15%
5	±0.06%
10g	±0.03%

The preceding table is based on the assumption that the sample is ideal, homogeneous and its moisture can always be separated completely and free from decomposition (e.g. moist sand). Deviations always comprise the uncertainty, which depends on the sample, and the repeatability of the instrument. In practice, measurement differences appearing within a measurement series can consequently be larger than the values of the halogen Moisture Analyzer shown in the table.

The two examples below show how the sample weight is determined to keep the drying time to a minimum and meet the accuracy demands of the instrument.

Example 1

The repeatability should be better than $\pm 0.15\%$. The accuracy table shows that a sample weight of at least 2g is required to achieve this.

Example 2

Wet weight of sample:	10g
Mean value of the results:	15.5%
Repeatability from the table:	±0.03%
Scatter of the measurement results (ideal sample)	15.47% – 15.53%

8.3 Selection of the drying temperature

The drying temperature exerts a controlling influence on the measurement time. It must be selected so that the sample neither decomposes nor changes its chemical structure. A drying temperature that is too low can unnecessarily prolong the drying time.

Note also that certain samples can give off different amounts of moisture at different drying temperatures. This is the case with substances in which the strength of the bonds binding the moisture varies or those which tend to show signs of decomposition. Minimum deviations from moisture content values of the reference method can be compensated by changing the drying temperature.

8.3 Selection of the drying temperature (cont)

The following procedure is suggested for selecting the temperature.

- Estimate moisture content of the sample.
- Determine the decomposition temperature of the sample by experiments.
- Compare the measurement results with the reference method if one exists.
- If an excessive amount of moisture is evolved, lower the drying temperature. If the experimental results are too low, the drying temperature was possibly too low or the drying time too short.

With samples which have a high moisture content, it is possible to shorten the measurement time by selection of the step or rapid drying program. Here, the greatest part of the existing moisture is separated at an elevated temperature.

The drying temperature is then lowered and kept constant until the end of drying. The excessive temperature is used for rapid

vaporization of the moisture, but the effective sample temperature does not exceed the boiling temperature of the liquid (cooling effect through endothermic vaporization). In certain cases, local heating and decomposition could still occur at the sample surface.

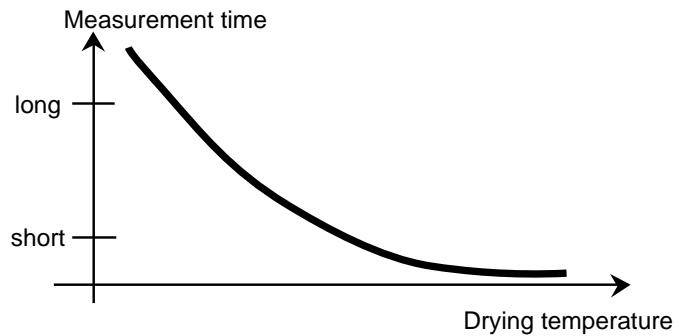

8.4 Selection of the drying program

Various drying programs are available in the Halogen Moisture Analyzer. There are four programs which control the temperature profile. They are:

- Standard drying program
- Fast drying program
- Ramp drying program
- Step drying program

Standard drying

Standard drying is suitable for precise determination of the moisture content of most substances. For special cases or for time optimized measurements, the selection of a more complex drying program may be advantageous.

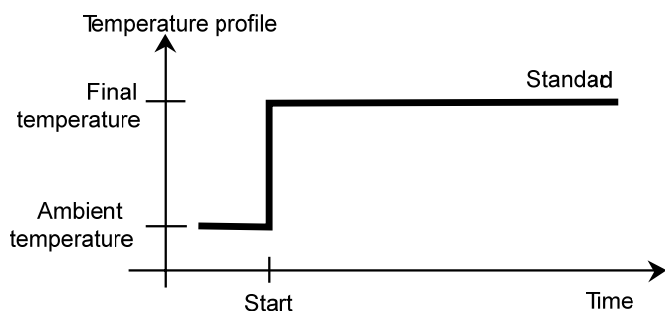

Ramp drying

Ramp drying is selected if substances are not stable on exposure to the full heating power of the halogen radiator at the start. In ramp drying, sensitive samples are prevented from decomposition by the gentle heating. Ramp drying can also be used successfully with substances which form a skin.

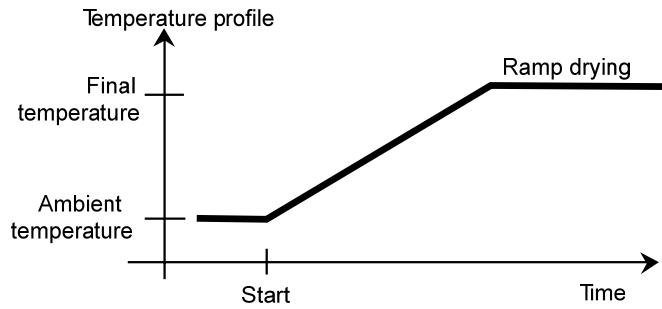

Fast drying

The fast drying program is suitable for samples with a moisture content between 5% and 15%. In fast drying, the radiator power exceeds the set temperature value during the first minute following the start of drying. This compensates the endothermic heat of vaporization and accelerates the drying process. Note that the sample must contain sufficient moisture during the first minute to cool it.

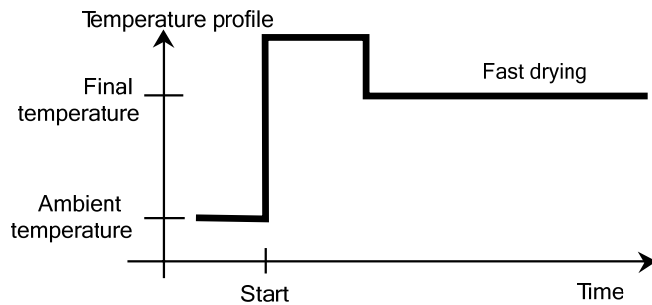

Step drying

The step drying program has a use similar to that of fast drying. The duration of the excessive temperature stage and the temperature value are freely selectable. It is used primarily with samples with a moisture content greater than 15%.

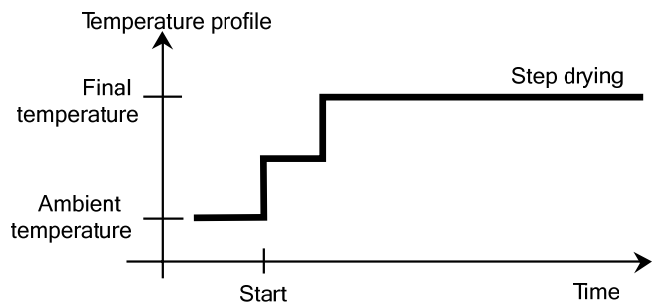

An alternate application possibility lies in the selective determination of the moisture at different temperatures. Gypsum, for example, releases only its surface water at 50°C, whereas the water of crystallization can not be separated until 168°C. With this drying program, it is thus possible to determine the surface water and the water of crystallization separately within the same measurement by a controlled temperature profile.

8.5 Selection of the drying time

The Halogen Moisture Analyzer offers two different types of switch-off criteria. A switch-off criterion is understood to mean the condition which must be met for the Halogen Moisture Analyzer to switch off automatically and end the drying.

The first type is a timed switch-off. This is used primarily when the drying process does not attain a constant final value and the sample continuously loses mass over time through decomposition or the evolution of difficult to volatilize components.

The second type recognizes the end of drying automatically. The integrated balance continuously determines the weight loss of the sample during drying. If the weight loss per unit of time is less than the set level, the drying is stopped and the final result is displayed.

Auto Switch Off

The automatic switch-off criterion is divided into three selectable levels:

- **A30**: Less than 1 mg loss in 30 seconds, used for rapidly drying substances.
- **A60**: Less than 1 mg loss in 60 seconds, used for standard samples.
- **A90**: Less than 1 mg loss in 90 seconds, used for slow drying substances (e.g. plastics).

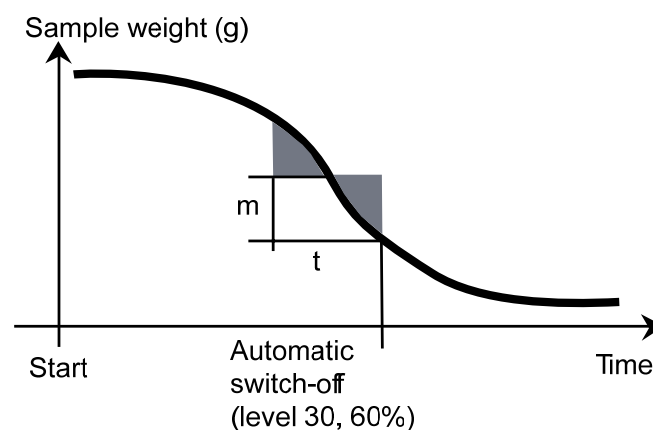

AFree switch-off criterion

The Auto Free switch-off criterion is based on a user defined mean weight loss per unit of time. As soon as this drops below the preset value, the measurement is automatically ended.

Manual

With this switch-off criterion, the measurement process continues until you stop it with the **STOP** button. The elapsed time is shown in the display.

Timed switch-off

With this switch-off criterion, the measurement lasts until the preset drying time has elapsed.

8.6 Analysis of the drying profile

In the first type, the drying profile is asymptotic. The amount of moisture lost assumes a constant value and no longer changes after long drying times. With this drying profile, repeatable determinations of the moisture content are always simple.

The measurement result then corresponds exactly to the constant value of the asymptote. It is also correspondingly easy to find a suitable switch-off criterion.

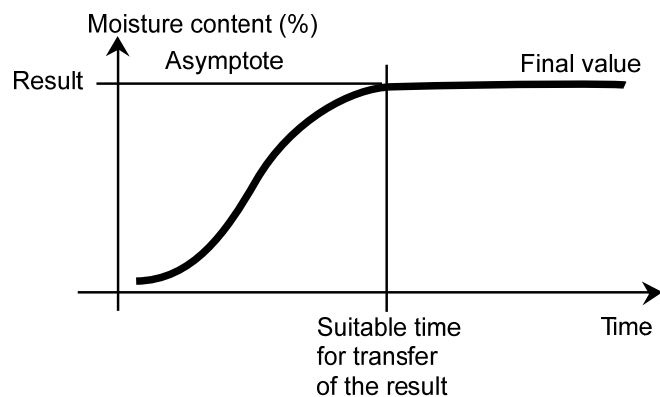

In the second type, drying runs quickly at the start and then flattens out. The moisture content never assumes a constant value. The causes of such a drying profile can be as follows:

The sample exhibits thermal decomposition, the decomposition products vaporize and the sample continuously loses weight. Fats, oils, plasticizers or other volatile components can lead to superimposed profiles owing to their slower vaporization than water. The difficult to volatilize components lead to a slow, continuous decrease in weight.

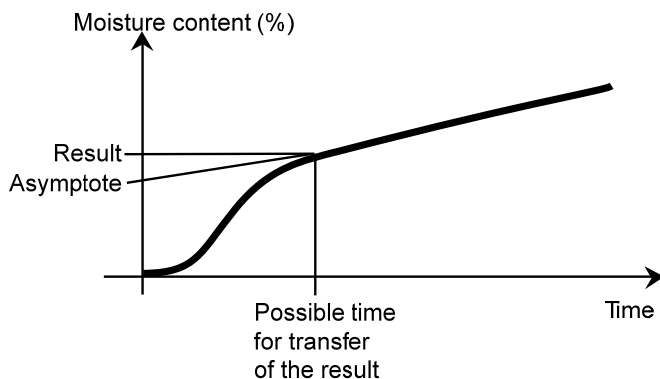

Measurement results of such a drying profile can be optimized:

- Lowering the temperature can slow down the decomposition reaction.
- The selection of a suitable switch-off criterion can allow recognition of the end of the analysis at the desired break point of the drying curve.
- The selection of a constant drying time often provides good measurement results.
- Keep the initial weight of the sample constant ($\pm 10\%$... $\pm 20\%$).

9. Printing Test Data

Printing data to an external computer or printer requires the communication parameters be set first.

Printing to an external printer or computer will occur each time the **Print** button is pressed. If the Print Interval is set in the Test Menu, printing can occur in a continuous fashion at specified intervals.

Samples of weight calibration, temperature calibration and test data (GLP on and GLP off) are shown as follows:

Weight calibration printout

```

WEIGHT CALIBRATION #12

DATE: 12.19.01
TIME: 11:20

OHAUS MB45
S/N: 1234567

REFERENCE WT: .....
WEIGHT: 20.000 G

CALIBRATION PERFORMED

SIGNATURE:

[.....]
[-----END-----]

```

Temperature calibration printout

```

TEMPERATURE CAL#12

DATE: 12.19.01
TIME: 11:25

OHAUS MB45
S/N: 1234567

TEMP REFERENCE ID.....
TEMP 100C: 103C
TEMP 160C 161C

CALIBRATION PERFORMED

SIGNATURE:

[.....]
[-----END-----]

```

Test data printout

GLP ON, Interval at 30 seconds. Pressing Print will add additional lines to data.

```

MOISTURE DETERMINATION
OHAUS MB45 SN 1234567

TEST ID: 120201 A

Switchoff Mode.   AUTO 60
Drying Profile.   STANDARD
Drying Temp.      100C
Result Units      %MOISTURE
Initial Weight.   10.098G

00:00:30  85C  9.17 %MC
00:01:00  99C 12.35 %MC
00:01:30 100C 15.28 %MC
00:02:00 100C 21.94 %MC

00:03:13 100C 24.64 %MC

00:05:00 100C 29.36 %MC
00:05:21 100C 31.94 %MC
Elapsed Time.   00:05:21
Initial weight. 10.098 GRAMS
Final Weight.   6.873 GRAMS
Final Result.   31.94 %MC

[---12.19.01-----15:35-----]
[-----END-----]

```

Statistics printout

```

STATISTICS

TEST ID: 120201 A

Sample N :           6
Mean X :           87.01 %MC
Standard Deviation S : 2.06 %MC
Minimum X :         83.47 %MC
Maximum X :         88.98 %MC
Absolute Difference : 5.51 %MC

[---12.19.01-----15:35-----]
[-----END-----]

```

Data only printout

GLP OFF, Interval at 30 seconds. Pressing Print will add additional lines to data.

```

00:00:30  85C  9.17 %MC
00:01:00  99C 12.35 %MC
00:01:30 100C 15.28 %MC
00:02:00 100C 21.94 %MC

00:03:13 100C 24.64 %MC

00:05:00 100C 29.36 %MC

```

9.1 RS232 Command Table

Output Formats

Data output can be initiated in one of three ways:

1. By pressing the **Print** button;
2. Using the Print Interval feature;
3. Sending a print command ("P") from a computer.

RS232 Commands

All communication is accomplished using standard ASCII format. Only the characters shown in the following table are acknowledged by the Moisture Analyzer. Invalid command response "ES" error indicates the Moisture Analyzer has not recognized the command. Commands sent to the Moisture Analyzer must be terminated with a Line Feed or carriage return-line line feed (CRLF). Data output by the Moisture Analyzer is always terminated with a carriage return-line feed (CRLF).

RS232 COMMAND TABLE

Command Character	Description
V	Print SR Version
ESC V	Print S/N (unit ID)
?	Print current mode.
TIME	Print Current Time
DATE	Print Current Date
P	Print elapsed time and present reading

9.2 RS232 Pin out

The following table illustrates the pin-out connections on the RS232 connector.

1		N/C
2	<-	Date Out (TXD)
3	->	Date Out (RXD)
4&6		Pins 4 and 6 are connected together.
5		Ground
7	->	Clear to send (CTS)
8	<-	Request to send (RTS)
9		N/C

10. Care and Maintenance

In this section, you will learn how to keep your Moisture Analyzer in good condition and how to replace expendable parts.

10.1 Cleaning Interior/Exterior Components

To continue to obtain precise measurements, it is advisable to clean the interior components at regular intervals. Please note the following instructions for cleaning your instrument.

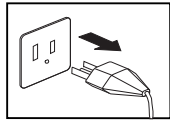

Disconnect the instrument from the power supply before cleaning.

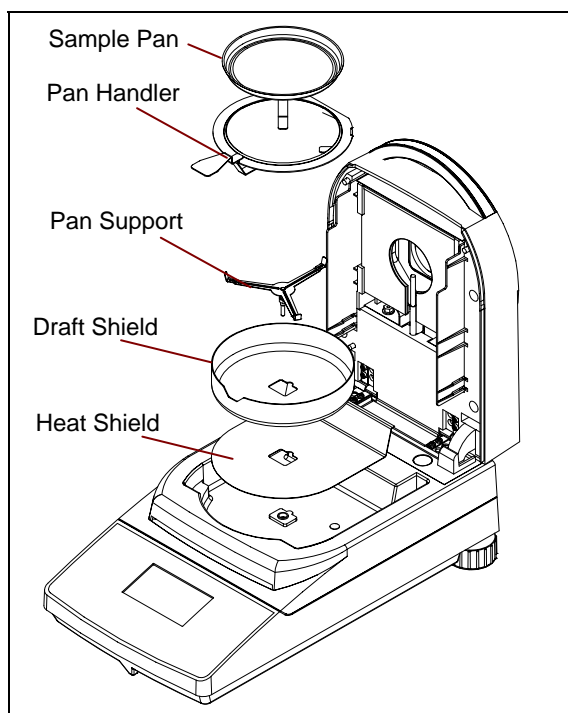

Open the cover and remove the pan handler, sample pan, draft shield, and heat shield from the instrument before cleaning.

Use a lint-free cloth for cleaning.

Clean the exterior of the instrument and the drying compartment components with a mild cleaning agent. Although the housing is extremely rugged and resistant to solvents, never use abrasive cleaning agents or solvents!

Ensure that no liquid enters the interior of the instrument.

Replace the components after cleaning.

10.1 Cleaning Interior/Exterior Components (cont)

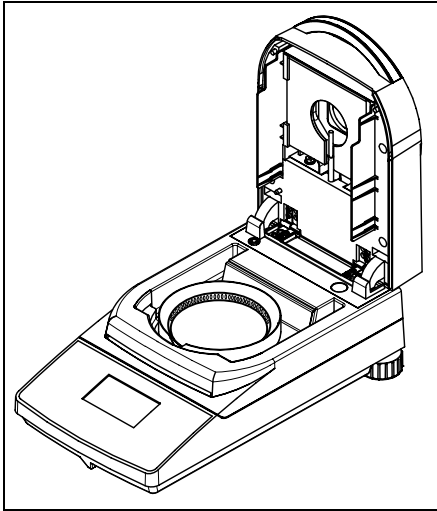

Cleaning Temperature Sensor and Protective Glass

Check the protective glass and the temperature sensor for debris which could impede the operation. If the glass appears dirty, clean the surface facing the compartment using a commercial glass cleaner. If the sensor is dirty, clean using a mild cleaning agent.

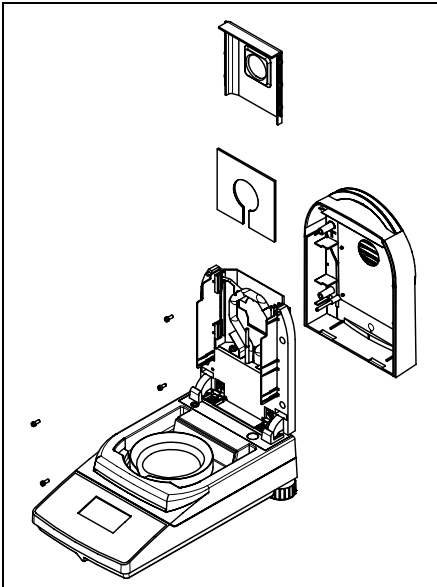

Removing Glass for Cleaning

If the inside of the glass is dirty, open the cover and remove the four cover screws as shown.

Remove the glass holder and glass from the cover and clean with a commercial glass cleaner on both sides.

Reassemble after cleaning.

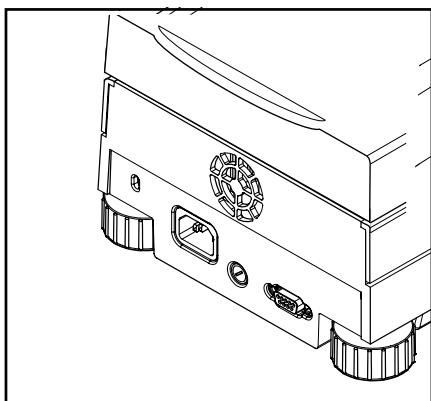

Cleaning air inlet

The air inlet of the fan is located at the rear of the instrument and its exterior should be cleaned from time to time to free it from any dust deposits.

10.2 Replacing Power Line Fuse

If the instrument display fails to light after switching it on, check the power outlet first. If power is available, and the instrument fails to operate, the power fuse may be open (blown).

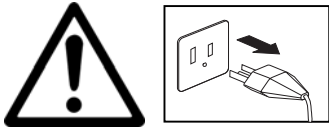

Disconnect the instrument from the power supply before cleaning.

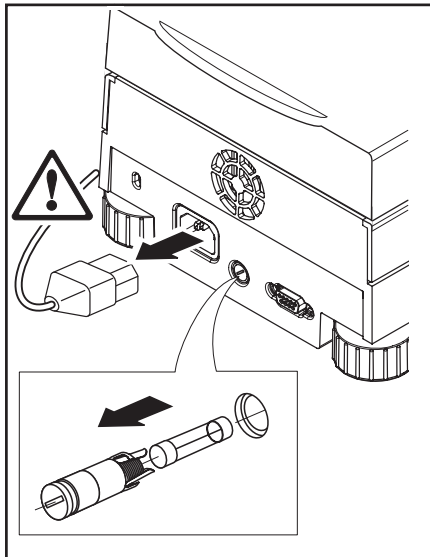

Using a screwdriver, turn the fuse holder to the left (counterclockwise) and remove the fuse.

Check the condition of the fuse. Replace blown fuse by those of the same type with the same rated value (5 x 20 mm, T6.3H 250 V).

NOTE: If the fuse is good and power is available at the outlet, the cord or instrument may be defective. Try a new cord. If this does not work, the instrument should be sent back for servicing.



The use of a fuse of a different type or with a different value, or bridging or shunting the fuse is not allowed and can possibly cause a hazard to your safety and lead to instrument damage!

10.3 Resetting the dryer thermal overload device

Access Hole Cover

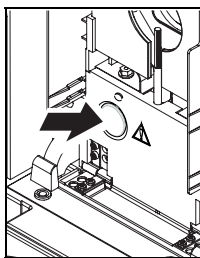

NOTE: This procedure only applies to units that contain an access hole to the thermal overload protection device. See illustrations.

If the dryer has overheated and the thermal overload protection device has responded, it can be reset as follows:

Disconnect the unit from the power supply.

Lift the top cover straight up and remove the access hole cover from the access hole using a flat head screwdriver.

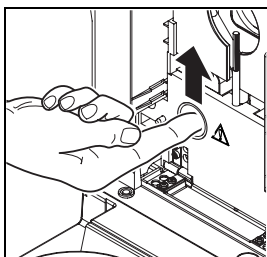

Reset the overload device with your finger.

Replace the access hole cover and reconnect unit to power supply.

10.4 Troubleshooting

Problem: Display remains dark after switching ON.

Probable causes:

- No line voltage
- Power cable not connected
- Power line fuse blown
- Instrument faulty

Problem: The measurement takes too long.

Probable cause: — You have selected an unsuitable switch-off criterion. Try experimentation to arrive at a suitable switch-off criterion.

Problem: The instrument does not heat following the start up.

Probable cause: — The dryer is overheated and the thermal overload protection has responded. For safe operation, the instrument is equipped with a duplicate overheating protection device: The dryer unit has a thermal overload protection device which switches off the heating element. Units containing an access hole allow the thermal overload protection device to be reset manually. Refer to paragraph 10.3 for instructions. On units that do not contain an access hole, contact your OHAUS dealer.

Problem: The measurements are not repeatable.

Probable causes:

- The samples are not homogeneous, i.e. they have different compositions. The more inhomogeneous a sample, the larger the amount of sample needed to obtain a repeatable result.
- You have selected a drying time that is too short. Extend the drying time or select a suitable switch-off criterion "Weight loss per unit of time".
- The sample does not come completely dry (e.g. owing to skin formation). Dry the sample on quartz sand.
- You have selected a temperature that is too high and the sample has oxidized. Lower the drying temperature.
- The sample boils and the splashed drops continuously change the weight. Lower the drying temperature.
- Insufficient heating power as the protective glass is dirty. Clean the protective glass.
- The temperature sensor is contaminated or faulty. Clean the temperature sensor.
- The support on which the instrument is standing is not stable. Use a stable support.
- The surroundings are very unstable (vibrations etc.).

10.5 Error detection

The Moisture Analyzer utilizes an audio tone to indicate an error. A *normal* button press or entry results in a short, high pitched tone. When an entry is incorrect or an improper button is pressed, a low pitched tone is emitted. There are no system error codes shown on the displays.

10.6 Service information

If the Troubleshooting section does not resolve or describe your problem, you will need to contact an authorized Ohaus Service Agent. For Service assistance in the United States, please call Aftermarket, Ohaus Corporation toll-free at (800) 526-0659. An Ohaus Product Service Specialist will be available to help you.

10.7 Accessories

Description	Ohaus Part No.
Span Calibration Mass 20 g ASTM Class 1 Tolerance	80780022
Security Locking Cable	80850043
RS232 Interface Cable, 9 pin serial extension - PC to MB45	80500525
RS232 Interface Cable, MB35 to printer (25 pin) SF42	80500571
Data Printer	SF42
Sample Pans 90mm diameter	80850086
Glass Fiber Pads	80850087
Pan, Re-usable - 90mm (set of three)	80850088
In-use Cover	80850085
Temperature Calibration Kit	11113857

11. Technical Data

11.1 Specifications

Model MB45	
Capacity	45g
Readability	0.001g, 0.01%
Results	Moisture (%), dry content (%), Wt (g), Wt (custom), regain, %
Temp. Settings	50°C to 200°C
Drying Programs	Standard, fast, ramp, step
Switch-off Criteria	Timed, Auto (30, 60, 90 seconds, auto free), manual
Heat Source	Halogen
Calibration	External calibration mass-20g
Dimensions (DxWxH) (in / cm)	14 x 7.5 x 6 / 35.5 x 19 x 15.2
Pan Size	90 mm. diameter
Adjustable Feet and Level	Yes
RS232 Interface	Yes
Weight (lb / kg)	9.8 / 4.5
Shipping Weight (lb / kg)	14.1 / 6.4



Admissible ambient conditions

Indoor use only

Altitude:	Up to 2000m
Temperature range:	5 °C to 40 °C
Atmospheric humidity:	Maximum relative humidity 80% for temperatures up to 31 °C decreasing linearly to 50% relative humidity at 40 °C.
Warm-up time:	At least 60 minutes after connecting the instrument to the power supply; when switched on from standby-mode, the instrument is ready for operation immediately.
Voltage fluctuations:	Mains supply voltage fluctuations up to -15% +10% of the nominal range
Over voltage category:	II
Pollution degree:	2
Power load:	Max. 450 W during drying process
Current consumption:	4 A or 2 A, according to the heating element
Power supply voltage:	100 V – 120 V or 200 V – 240 V, 50/60 Hz (the voltage is given by the heating element)
Power line fuse:	1 piece, 5 x 20 mm, T6,3 H 250 V

11.2 Compliance

Compliance to the following standards is indicated by the corresponding mark on the product.

Marking	Standard
	This product conforms to the EMC directive 2004/108/EC, the Low Voltage Directive 2006/95/EC. The complete Declaration of Conformity is available online at www.ohaus.com .
	AS/NZS4251.1, AS/NZS4252.1
	CAN/CSA C22.2 No. 61010-1-04, UL Std No. 61010A-1

FCC Note

This equipment has been tested and found to comply with the limits for a Class B digital device, pursuant to Part 15 of the FCC Rules. These limits are designed to provide reasonable protection against harmful interference when the equipment is operated in a commercial environment. This equipment generates, uses, and can radiate radio frequency energy and, if not installed and used in accordance with the instruction manual, may cause harmful interference to radio communications. Operation of this equipment in a residential area is likely to cause harmful interference in which case the user will be required to correct the interference at his own expense.



Industry Canada Note

This Class B digital apparatus complies with Canadian ICES-003.

ISO 9001 Registration

In 1994, Ohaus Corporation, USA, was awarded a certificate of registration to ISO 9001 by Bureau Veritas Quality International (BVQI), confirming that the Ohaus quality management system is compliant with the ISO 9001 standard's requirements. On May 21, 2009, Ohaus Corporation, USA, was re-registered to the ISO 9001:2008 standard.

Disposal

 	<p>In conformance with the European Directive 2002/96/EC on Waste Electrical and Electronic Equipment (WEEE) this device may not be disposed of in domestic waste. This also applies to countries outside the EU, per their specific requirements.</p> <p>The Batteries Directive 2006/66/EC introduces new requirements from September 2008 on removability of batteries from waste equipment in EU Member States. To comply with this Directive, this device has been designed for safe removal of the batteries at end-of-life by a waste treatment facility.</p> <p>Please dispose of this product in accordance with local regulations at the collecting point specified for electrical and electronic equipment.</p> <p>If you have any questions, please contact the responsible authority or the distributor from which you purchased this device.</p> <p>Should this device be passed on to other parties (for private or professional use), the content of this regulation must also be related.</p> <p>For disposal instructions in Europe, refer to www.ohaus.com, choose your country then search for WEEE.</p> <p>Thank you for your contribution to environmental protection.</p>
--	---

A1. Application examples

This appendix includes a table indicating problems specific to various substances and their possible solution. The samples were selected so that representatives of many material classes are considered. For the solution to your specific problem, a substance similar to your sample can be selected from the list.



APPLICATION DISCLAIMER:

— Moisture determination applications must be optimized and validated by the user according to local regulations. Application specific data provided by Ohaus is provided for reference purposes only. Ohaus waives all liability for applications based on this data.

TABLE A-1 COMPILATION OF APPLICATIONS WITH THE OHAUS MOISTURE ANALYZER

Substance/Sample	Sample weight (g)	Temperature program	Drying temperature	Switch-off criterion	Mean value of result	Results	Measurement time
Food							
Wheat flour	3.0	Fast	180°C	A60	14.00%	0.11%	4
Dried vegetables	2.5	Fast	105°C	A30	7.66%	0.12%	2-2.5
Wet vegetables (spinach)	5.0	Step	7 min. 200°C, 1 min. 150°C, 105°C	A30	82.57%	0.18%	9.5
Butter	3.0	Step	2 min. 150°C, 130°C	A60	17.14%	0.10%	4.5
Processed cheese	3.0	Step	7 min. 180°C, 150°C	A30	43.30%	0.25%	13
Marzipan filling	0.8	Standard	105°C	20 min	8.19%	0.30%	20
Fruit juice concentrate	3.0	Step	4 min. 200°C, 105°C	A60	59.14%	0.25%	10
Pastry	4.5	Step	2 min. 170°C, 130°C	A60	32.25%	0.010%	11
Whole egg with 10% salt	1.8	Fast	130°C	A60	69.61%	0.10%	6
Powdered milk	5.0	Fast	105°C	A60	3.38%	0.11%	5.5
Potato chips	9.0	Fast	95°C	A30	0.70%	0.07%	2
Herbs and spices	5.0	Fast	105°C	A30	6.38%	0.11%	3
Honey	0.7	Step	5 min. 130°C, 105°C	A60	17.23%	0.21%	6
Coffee water-soluble	5.0	Standard	103°C	A60	3.67%	0.05%	5
Tobacco	2.5	Fast	105°C	A60	11.96%	0.10%	4
Construction & Plastics							
Clay body	10	Standard	200°C	A30	2.47%	0.06%	1.5
Gypsum (water of crystallization of gypsum)	5.0	Step	4 min. 105°C, 200°C	20 min	27.45%	0.045%	20
Dispersions	2.5	Fast	170°C	A30	74.22%	0.17%	5
Wood (2-3-1cm)	4.0	Fast	180°C	A90	14.34%	0.17%	14
Latex	1.5	Fast	170°C	A60	48.69%	0.20%	2
Cellulose (paper)	5.0	Fast	190°C	A60	69.77%	0.05%	12
Cosmetics/ Pharmaceuticals							
Suntan cream (emulsion)	0.5	Fast	105°C	A90	82.12%	0.33%	8-10
Acetylsalicylic acid	2.5	Ramp	Ramp 3 min., 105°C	A60	1.52%	0.10%	3.5
Environment/ecology							
Sewerage sludge	1.0	Step	3 min. 130°C, 105°C	A60	96.96%	0.15%	5

Comments on the table

Wheat flour

Direct weighing-in.
No visible coloration due to decomposition.

Dried vegetables

Beans milled in grinder.
Drying profile not asymptotic, hence sample weight not greater than 2.5g dried vegetables.
Rapid drying for relatively short measurement time.
After drying, slight browning of dried vegetables.
Always use the same amount of sample.

Wet vegetables

Chopped spinach.
Dried on (glass fiber pad).
No visible coloration due to decomposition.

Butter

Butter vigorously mixed in cylindrical vessel using glass rod.
Dried on (glass fiber pad).
No visible coloration due to decomposition.

Processed cheese

Cheese grated.
Dried between 2 (glass fiber pads).
Melts during the drying process.
No visible coloration due to decomposition.

Marzipan filling

Small pieces pressed flat between two glass fiber pads.
Thickness including filter: <1mm.
Drying profile not asymptotic, hence low sample weight for short measurement time.

Fruit juice concentrate

Well shaken before weighing.
Dried between two glass fiber pads.
Slight browning of the samples.

Pastry

Spread thinly on aluminum disk.
Pastry baked slightly brown after drying.
Well puffed up before weighing.
Dried on glass fiber filter.
No skin formation in contrast to drying without glass fiber pad.
No visible coloration due to decomposition.

Powdered milk

Direct weighing-in.
No visible coloration due to decomposition.

Potato chips

Milled in grinder, oily pulp dried on glass fiber pad.
Drying profile not asymptotic, oil vaporizes very slowly at low temperatures, hence select low drying temperature, switch-off criterion 1.
Always use the same amount of sample.

Herbs and spices

Direct weighing-in.
Drying profile not asymptotic, flavoring materials volatile, hence select switch-off criterion: A30.
Always use the same amount of sample.

Honey

Melted in a closed vessel at 60°C.
Dried between 2 glass fiber pads.
No visible coloration due to decomposition.

Water-soluble coffee

Powder in a mortar. Drying profile not asymptotic. Different moisture values at different drying temperatures (flavoring materials). Caffeine sublimates above 178°C. Values comparable with reference method obtained at a drying temperature of 103°C.
No visible coloration due to decomposition.

Tobacco

Milled in a grinder.
Drying profile not asymptotic (flavoring materials volatile), hence select rapid drying for short measurement time, switch-off criterion: A60.
Always use the same amount of sample.

Clay body (powder)

Direct weighing-in.

Gypsum (moist)

Mix well, direct weighing-in.
Step drying program 4 min. 50°C, 200°C.
Timed switch-off criterion: 10 min.
Surface water after 4 min.
Total moisture after 10 min.

Dispersion

Weighing-in using a syringe.
Dried on glass fiber filter. No visible coloration due to decomposition.

Solid wood

Direct weighing-in.
(2 cm* 3 cm* 1 cm), drying profile not asymptotic.
Sample very inhomogeneous.
110°C: 12.3% Switch-off criterion: A60
130°C: 13.5% Switch-off criterion: A60
180°C: 14.3% Switch-off criterion: A60

Latex

Shake well.
Weighing-in using a syringe.
Dried between 2 glass fiber pads.
Slight odor of burnt styrene, but asymptotic drying profile.
Comparable results obtained at a drying temperature of 150C, but lengthy measurement time necessary.

Cellose

Cut up moist, pulpy cellulose fibers finely and break up.
No visible coloration due to decomposition.

Suntan cream (emulsion)

Direct weighing-in.
Dried on glass fiber pad.
No visible coloration due to decomposition.

Acetylsalicylic acid product

Sample powdered in a mortar.
No asymptotic drying profile, hence gentle drying 105C, use switch-off criterion: A60.
No visible coloration due to decomposition.
Always use the same amount of sample.

Sewage sludge

Shake well.
Dried on a glass fiber pad.

LIMITED WARRANTY

Ohaus products are warranted against defects in materials and workmanship from the date of delivery through the duration of the warranty period. During the warranty period Ohaus will repair, or, at its option, replace any component(s) that proves to be defective at no charge, provided that the product is returned, freight prepaid, to Ohaus.

This warranty does not apply if the product has been damaged by accident or misuse, exposed to radioactive or corrosive materials, has foreign material penetrating to the inside of the product, or as a result of service or modification by other than Ohaus. In lieu of a properly returned warranty registration card, the warranty period shall begin on the date of shipment to the authorized dealer. No other express or implied warranty is given by Ohaus Corporation. Ohaus Corporation shall not be liable for any consequential damages.

As warranty legislation differs from state to state and country to country, please contact Ohaus or your local Ohaus dealer for further details.



Ohaus Corporation
7 Campus Drive
Suite 310
Parsippany, NJ 07054 USA
Tel: (973) 377-9000,
Fax: (973) 944 -7177

www.ohaus.com

With offices worldwide.



P/N 80250891 E © 2011 Ohaus Corporation, all rights reserved.

Printed in Switzerland