

NETWORK ANALYZERS CVMk2

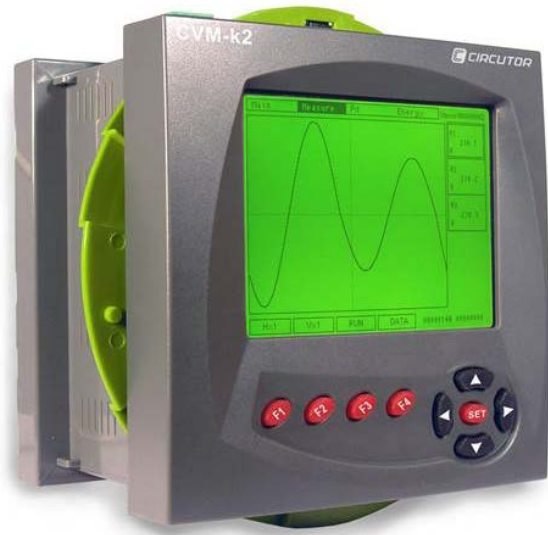

The CVMk2 is an instrument which measures, calculates and displays the main electrical parameters for three-phase industrial systems (balanced or unbalanced). Measurements are in true effective value, via three AC voltage inputs and three AC current inputs. (via IN /5A or IN /1A current transformers). The parameters measured and calculated are shown in the variables table.

This manual is a quick guide to the use and operation of the CVMk2. For more information, the whole manual may be downloaded from CIRCUTOR's web page: www.circutor.es

Warning: Before any maintenance, modification to the connections, repair, etc., the equipment must be disconnected from the supply. If any operation or protection fault is suspected the equipment must remain out of service ensuring against any accidental reconnection. The equipment is designed to be changed quickly in the event of any breakdown.

1 DISPLAY DESCRIPTION.

The display can show the values, measured, calculated and stored by the measuring modules. Display has the screen, the function buttons and movement buttons.

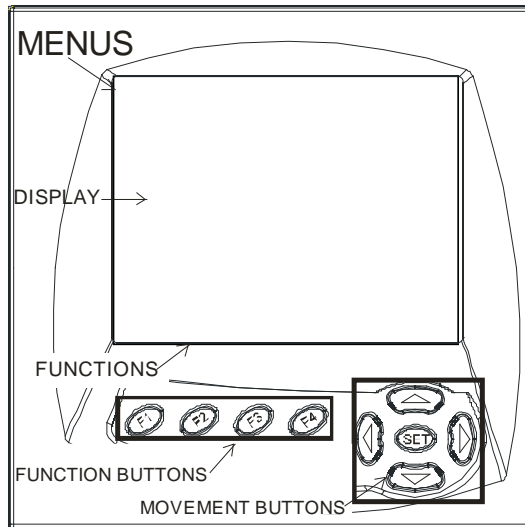

- Function buttons: Are identified with F1, F2, F3, F4 and serve to select the function that appears in the low part of the display.
- Movement buttons: They serve to move through the upper menu, into the setup screen and graphic screen.

To move through the options menu and select the wished options, use the movement buttons and press SET. The selected options, always appears in black bottom.

2 DISPLAY SETTINGS.

In this group of menus, you will be able to set all the parameters related to the display.

2.1 Display options

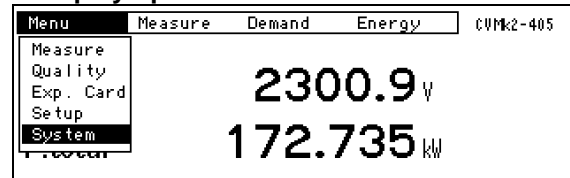

MENU → SYSTEM → PREFEREN. → DISPLAY
Here you will find all the options related to display's options.

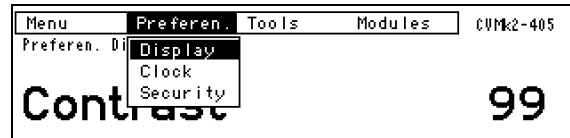

- Contrast: In this menu you can set the contrast in order to obtain a correct visualization.
- LCD OFF: It's possible to switch off automatically the display. Option YES, the display will switch off at the same time with the backlight. Option NO means that the display never will switch off.
- Backlight: To connect or disconnect the backlight, option NO disconnects permanently the backlight, option YES, switch on permanently the backlight, the others (20-90-180) are the seconds that will wait the backlight to switch off.
- Language: allows to set the language device.

2.2 Clock

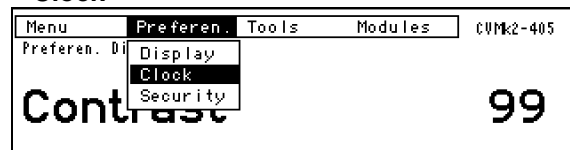

MENU → SYSTEM → PREFEREN → CLOCK

This screen allows to set the date and time of the device.

- Time: Allows to set the time of device, the hour format will be always of 24h.
- Date Type: Allows to set the date format in DD/MM/AA (day / month / year) or MM/DD/AA, (month / day / year)
- Date: Allows to set the actual date, the format will be the same that you edited into the previous option.

2.3 Security

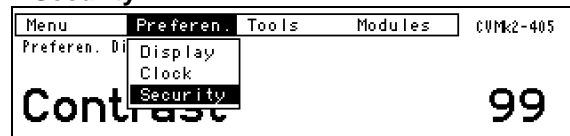

MENU → SYSTEM → PREFEREN → SECURITY

In this screen, you can set the preferences to block the access to unauthorized persons into setup screens.

- Lock: The option YES set a password blocking, that only allows to change the configuration to the authorized persons.
- Password: In case the a lock is set, you will need to introduce here the current password. The default password is 1234.
- New: If you want to change the password for a new one, you will need to set here the new value.
- Repeat: This field assures the correct introduction of the password. The introduced value must be equal than the introduced one in the previous option.

2.4 Device



MENU → SYSTEM → TOOLS → DEVICE

- Reset: Makes a complete RESET of the equipment, the same function than take off the power supply.
- UPDATE: This option set the device in BOOT mode, that allows to update the device.
- Baud disp.: Display communicates with the measuring modules through a RS485 network. Longs networks or with many devices, may be necessary to reduce the baud rate for good communications.

2.5 Connected measuring modules list

MENU → SYSTEM → MODULES

In this screen you will see the different measuring modules connected to the display.

3 BASIC SETTINGS FOR MEASURING MODULES.

The CVMk2 makes the measurement of multiple electric parameters., then we have to form different options of the device. This quick guide only tells the necessary to configure correctly.

3.1 Transformer relation

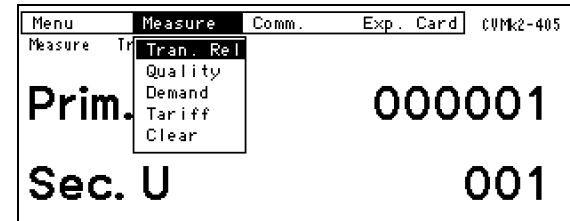

MENU → CONFIG → MEASURE → TRAN. REL

In this menu, we accede to the programming the primary and secondary relation of the voltage and current ratios.

- Prim. V: Allows programming the primary of voltage transformer. In case that transformer is not used, you should program "1".
- Sec. V: Allows programming the secondary of voltage transformer. In case that transformer is not used you should program "1".
- Prim. I: Allows programming the primary value of current transformer.
- Sec. I: Allows programming the secondary value of current transformer, the programmable values are... /5 or... /1.

3.2 Quality

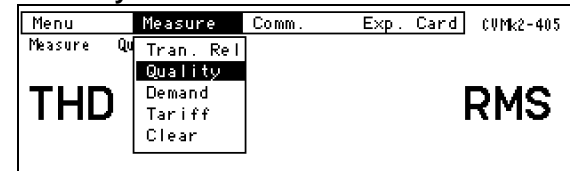

MENU → CONFIG → MEASURE → QUALITY

- THD Calc.: Allows to set the THD calculation using the fundamental wave or the RMS value.

3.3 Demand

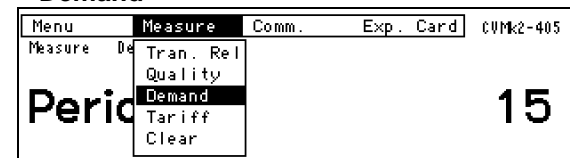

MENU → CONFIG → MEASURE → DEMAND

The CVMk2 calculates the maximum demand of the following values, triphasic active power, triphasic apparent power, intensity of the three phases and also the triphasic one. Different aspects for the calculation of the demand can be set, and are the following ones.

- Period: It's the time, in minutes, of maximeter function integration, can bet set from a minimum value of 1 minute and a maximum of 60.
- Window: Three types of window for demand calculation can be established, FIXED, SLIDING, THERMAL
- Syncro: Synchronism, the calculations of demand can be synchronized using an input of external impulses or by means of synchronization with an internal clock of equipment, an option selecting EXTERNAL or CLOCK can be chosen respectively.
- Input num: In the case that you had selected an impulse for external synchronism in the previous section, in this point you should indicate which input will receive the synchronism impulse.

3.4 Tariff

MENU → CONFIG → MEASURE → TARIFF

The CVMk2 allows the configuration of tariffs for the use of for example, energy meters.

- Tariff Num: Specifies how many different tariffs will be set.
- Calendar: Specifies if the CVMk2 uses the internal clock to manage the tariffs, (option CLOCK) or uses the inputs for it, (the impulse to change the tariffs would make another external equipment like for example a meter) EXTERNAL option.
- Input num: If you selected in CALENDAR, an external management of tariffs, in this point you should specify the input that will receive the impulse.

3.5 Clear

MENU → CONFIG → MEASURE → CLEAR

This screen allows delete the following values:

- All: All stored values.
- Maximums: Maximum values, dates and hours.
- Minimums: Minimum values, dates and hours

- Energy: Energy and Tariff accountants.
- Demand: The values of Maxima demand, including those of tariff.
- Ext. Count: The values of the input's impulses.

3.6 Comm

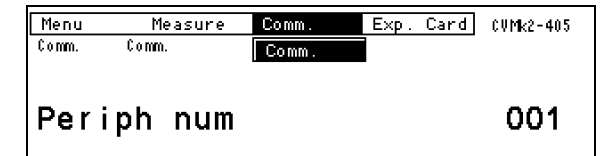

MENU → CONFIG → COMM → COMM

To program the communication's parameters of measurement modules. If you want to use a network RS-485, The parameters to program are:

- Periph num: It is the number of peripheral you want to use.
- Baud: Baud rate or communication speed that you will use.
- Parity: The parity used in the communications (NO-ODD-EVEN).
- Data bit: Numbers of data bits in the frame.
- Stop bit: Stop bits 1 - 2
- Protocol: MODBUS protocol.

4 TECHNICAL FEATURES

Product to be protected by an external fuse, model KTK-1 by Bussmann, or similar, rated 600V, 1A.

Power supply circuit: Single-phase:	85...265 Vac / 100...300 Vcc. CD model: 24VDC	
Voltage tolerance:	-15 % / +10 %	
Frequency:	50 ~ 60 Hz	
Maximum consumption:	30 VA, 25W	
Operating temperature:	-10°C+ 50 ° C	
Humidity (without condensation):	5% 95%	
Maximum altitude	2.000 m	
Mechanical features: Casing material:	Self extinguishing V0 plastic	
Protection:		
Assembled equipment (DISPLAY):	IP 51	
Non assembled equipment (MEASURING MODULE):	IP 31	
For use on a Flat Surface of a Type 1 Enclosure (only for the display module)		
Measure module dimensions (mm):	144 x 144 x 70 mm	
Screen dimensions (mm):	144 x 144 x 45 mm	
Weight:	0.750 kg	
Supply and voltage measure wires	minimum section 1 mm ²	
Secondary C. transformers wires	minimum section 2,5 mm ²	
Field Wiring terminals to use Copper	Conductors only, wire size AWG 14, minimum temperature rating 60°	
Accuracy class:	405 MODEL	402 MODEL
Voltage:	0,5 % ± 1 digit	0,2 % ± 1 digit
Current :	0,5 % ± 1 digit	0,2 % ± 1 digit
Power / Energy:	0,5 % ± 1 digit	0,2 % ± 1 digit
Power factor:	0.5...1	
Scale range measurement margin:	0,4%...120% / 0.2%...120%	
Measurement circuit:		
Rated voltage:	300 Vac Ph-n / 520 Vac Ph-ph	
Frequency:	45...65 Hz	
Rated current:	In/ 5 A or In/ 1 A.	
Permanent overload:	1.2 In	
Power consumption voltage circuit:	0.5 VA	
Power consumption current circuit		
ITF / Shunt	0.9 VA / 0,75 VA	
Safety:		
Category III - 300 V AC. / 520 AC. EN-61010 Class II double isolation against electric shock		
Standards:		
IEC 664, VDE 0110, UL 94, IEC 801, IEC 348, IEC 571-1, EN 61000-6-3, EN 61000-6-1, EN 61010-1, EN 61000-4-11, EN 61000-4-2, EN 61000-4-3, EN 61000-4-4, EN 61000-4-5, EN 55011		

5 TECHNICAL SERVICE

In case of any equipment failure or any operational queries please contact the technical service of CIRCUTOR S.A.

TECHNICAL ASSISTANCE SERVICE (TAS): (+34) 902449459.

CIRCUTOR S.A. - After sales service

Vial Sant Jordi, s/n

08232 - Viladecavalls (Barcelona)

Tel.: (+34) 93 745 29 00

Fax: (+34) 93 745 29 14

e-mail: central@circutor.es



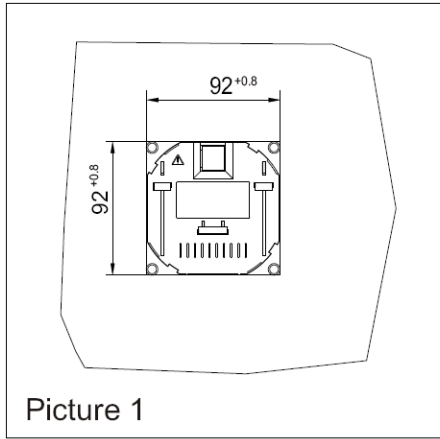

Picture 1

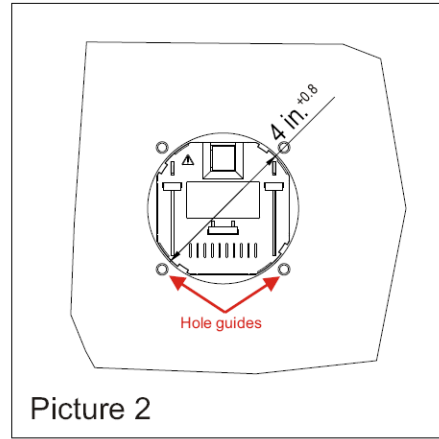

Picture 2

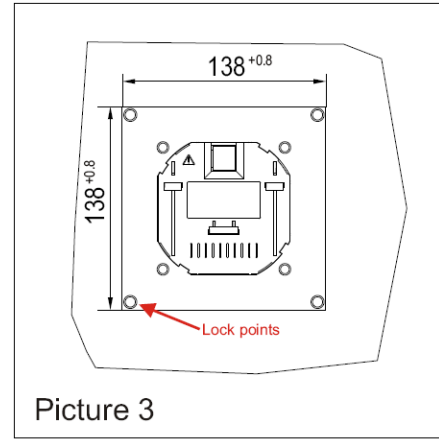

Picture 3

Pictures 1, 2 and 3: Shows the way you have to insert the display in the panel. You can insert the CVMk2 in three different measures of holes. One of 92x92mm (picture 1), other of 4 inch of diameter (picture 2) and the last one of 138x138mm (picture 3). After to insert the display, we have to insert the blocker hoop, making sure that the clamps are closed (picture 4) and the white arrow (picture 5) that indicates the way of the communications wire, indicates upwards.

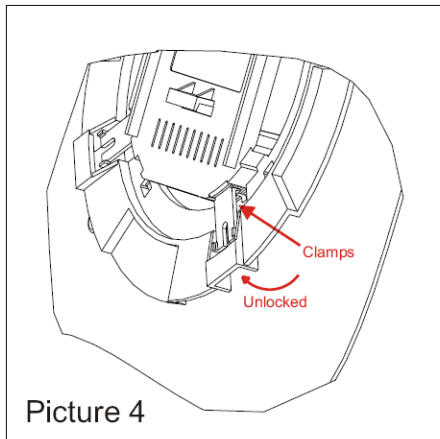

Picture 4

Picture 4: The clamps are the fixations elements of display to the panel. It's important to lock the display that the clamps were not blocked, so when we insert the hoop, the clamps remain fixed. In the same way, to disassemble the display, the clamps must be blocked. We have to open the clamps to remove the hoop.

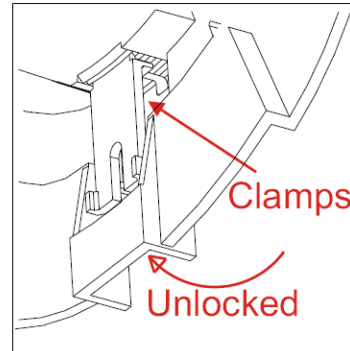

Picture 5: The arrow must indicate upwards as shows the picture, and must be in the same position that has the arrow in the black part of display.

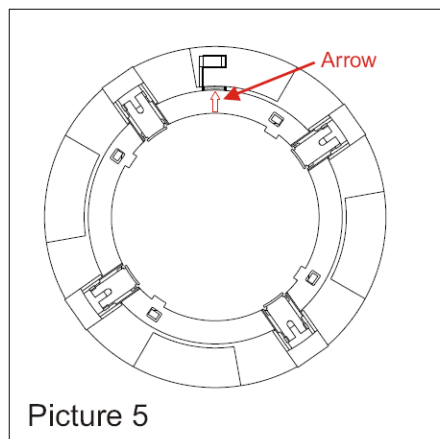

Picture 5

Picture 6: The assembly scheme is as shows picture 6. The measure unit could be mounted behind the locker hoop as shows the picture or could be mounted in DIN rail, and connected with the display by the wire RJ45 Straight.

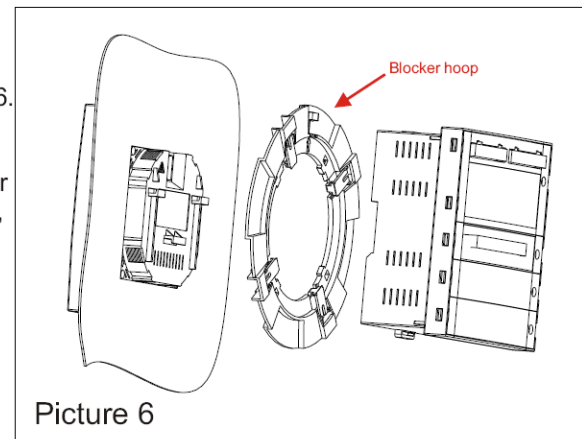

Picture 6

RJ45 Straight wire



Layout 4 Current T. (5 wires)

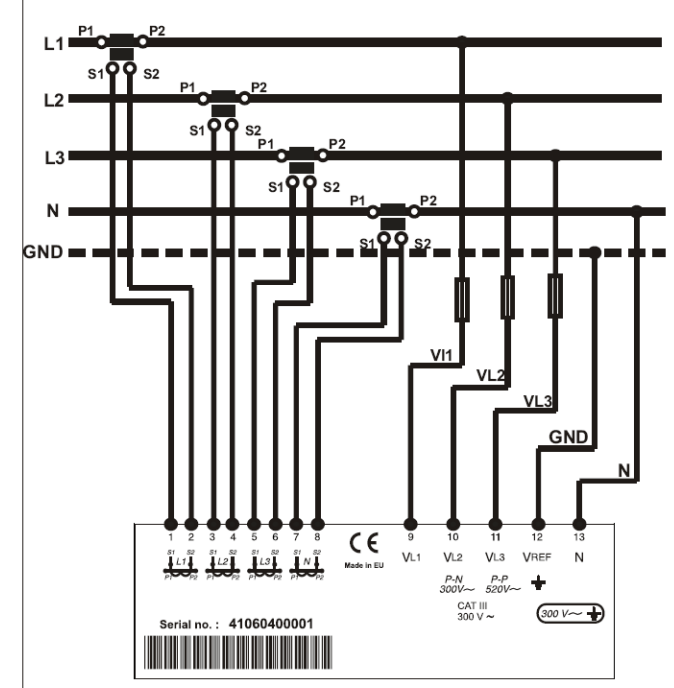

Layout 2 Current T. and 2 Voltage T.

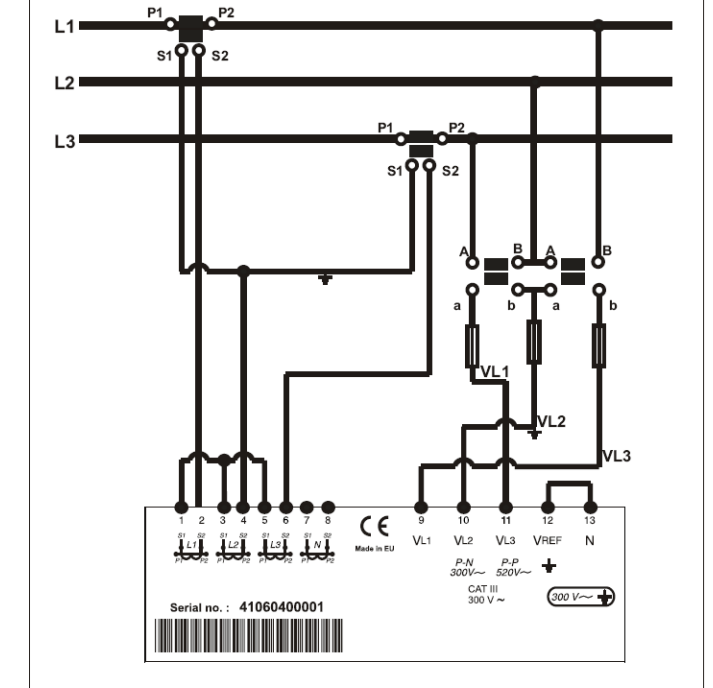

Layout 3 Current T. (3 wires)

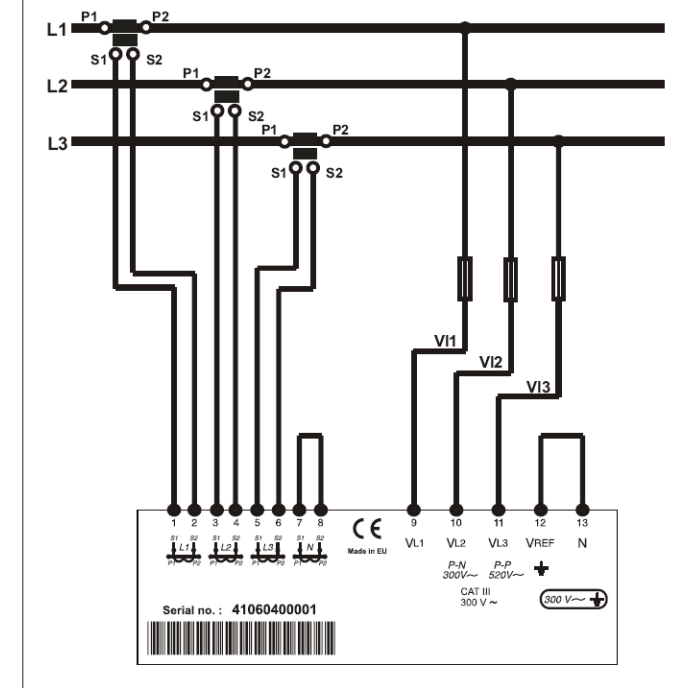

Layout 4 Current T. and 2 Voltage T.

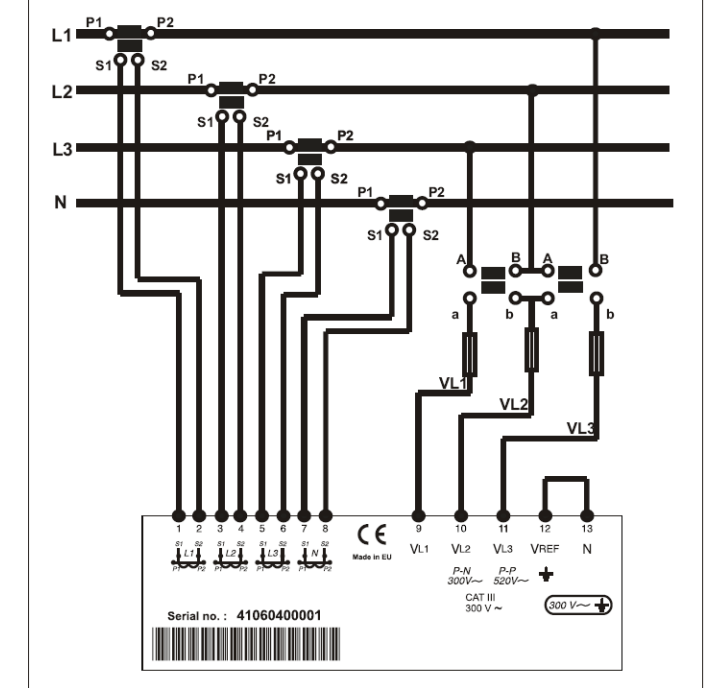

Communications

